

Torsional Oscillator. Part1.

Physics 401. Fall 2019
Eugene V. Colla



ILLINOIS

illinois.edu

10/7/2019

Physics 401

1

Transients in a Torsional Oscillator

- **Electrical RLC circuits**
- **Torsional Oscillator**
 - **Damping**
 - **Data Analysis**



Transients in RLC circuit.

$$V_R + V_L + V_C = V(t)$$

If $V(t)=0$

$$L \frac{d^2}{dt^2} q(t) + R \frac{d}{dt} q(t) + \frac{q(t)}{C} = 0, \quad \frac{q(t)}{C} = V_0$$

Damping term. Reflects energy dissipation in the resistor

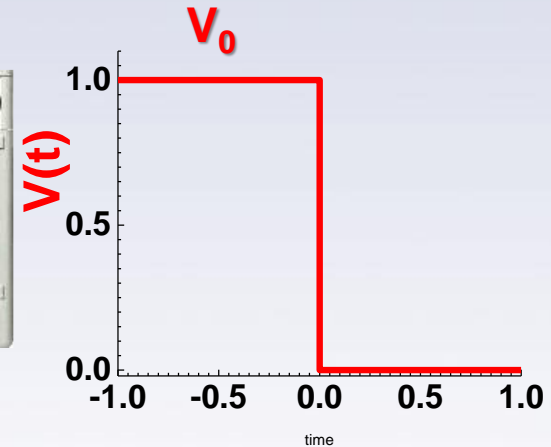
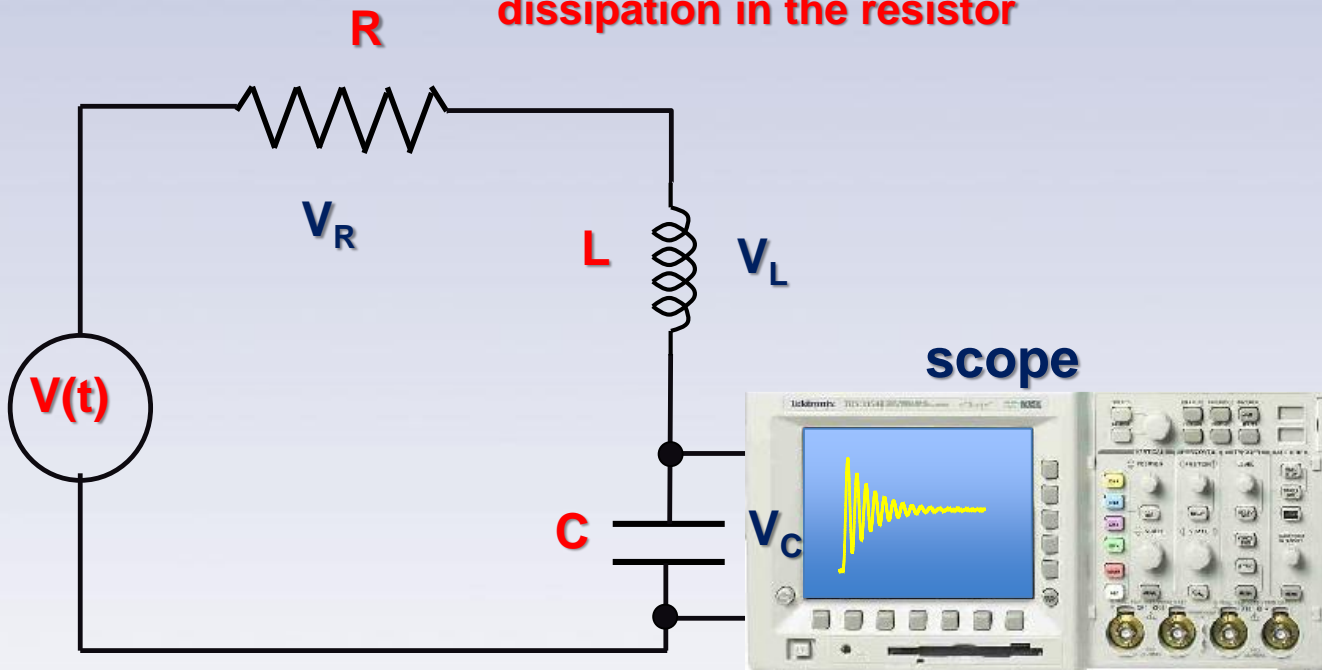

RLC: three solutions.

$$a = \frac{R}{2L}, \quad b = \sqrt{\left(\frac{R}{2L}\right)^2 - \left(\frac{1}{LC}\right)}$$

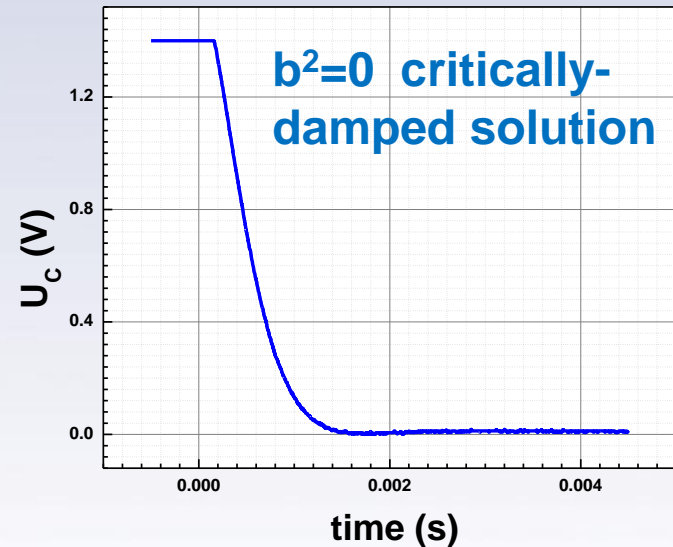
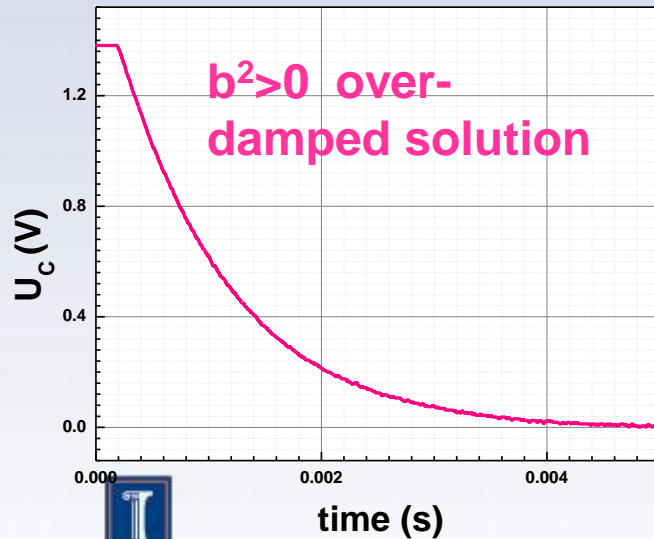
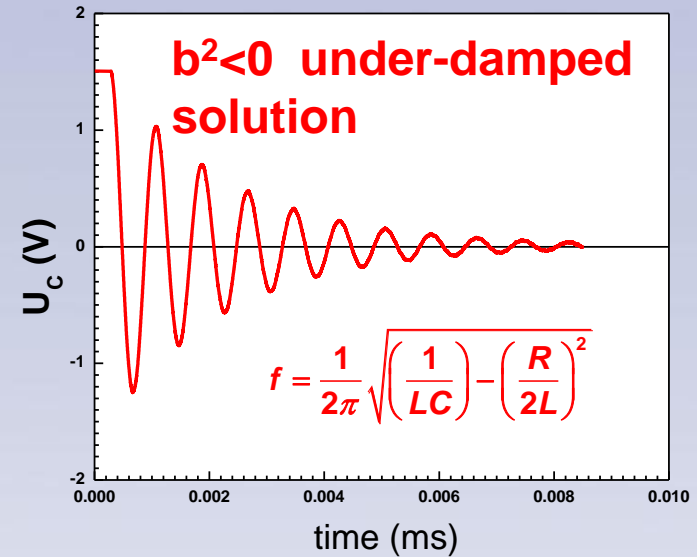

The Torsional Oscillator.

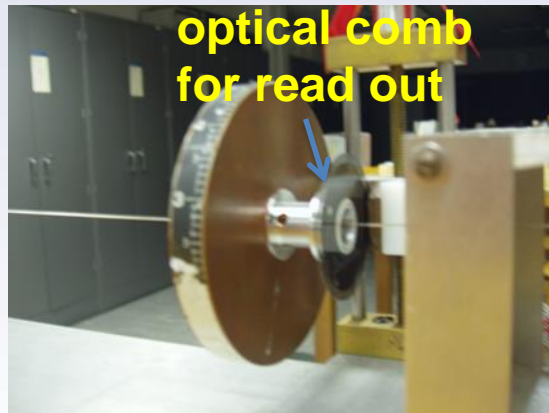
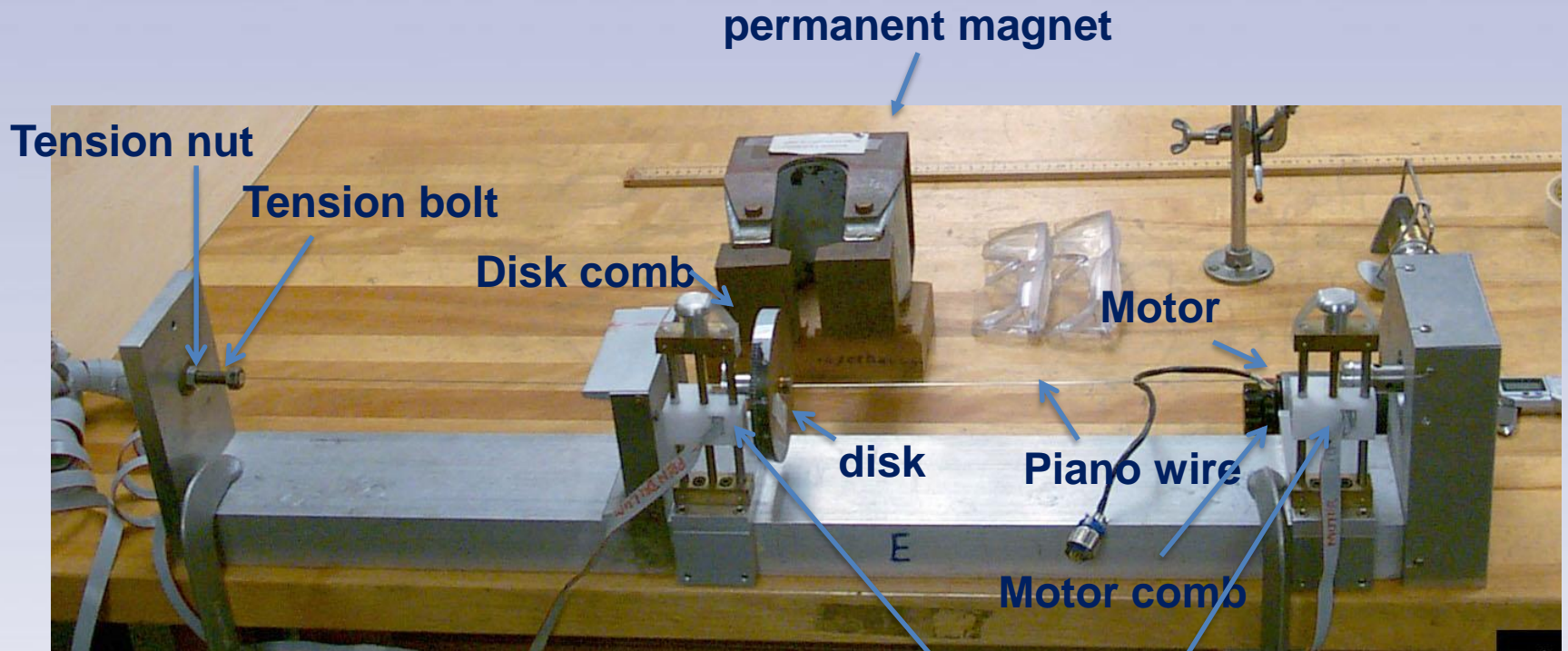

Optical sensors

**Momentum of Inertia I for disk
with radius R and mass M :**

$$I = \frac{MR^2}{2}$$



The Torsional Oscillator.

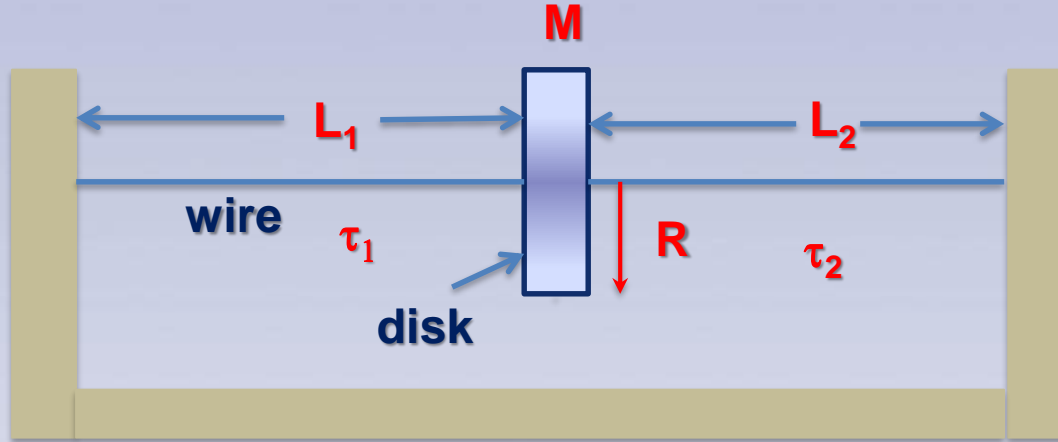

Wires 1 and 2 exert the torques τ_1 and τ_2 on the disk of mass M

$$\tau = \tau_1 + \tau_2 = -K_1\theta - K_2\theta = -K\theta$$

$$K_1 = \frac{\pi Gr^4}{2L_1}$$

θ : angular deflection of the disk
 r : radius of the wires
 L_i : length of the wire i
 G : shear modulus of the wire

A typical shear modulus for steel is $8.3 \times 10^{10} \text{ N/m}^2$

$$K = K_1 + K_2 = G \frac{\pi}{2} r^4 \left(\frac{1}{L_1} + \frac{1}{L_2} \right)$$

K – torsional spring constant



The Data Acquisition Setup and Program



DAQ rate (Hz)

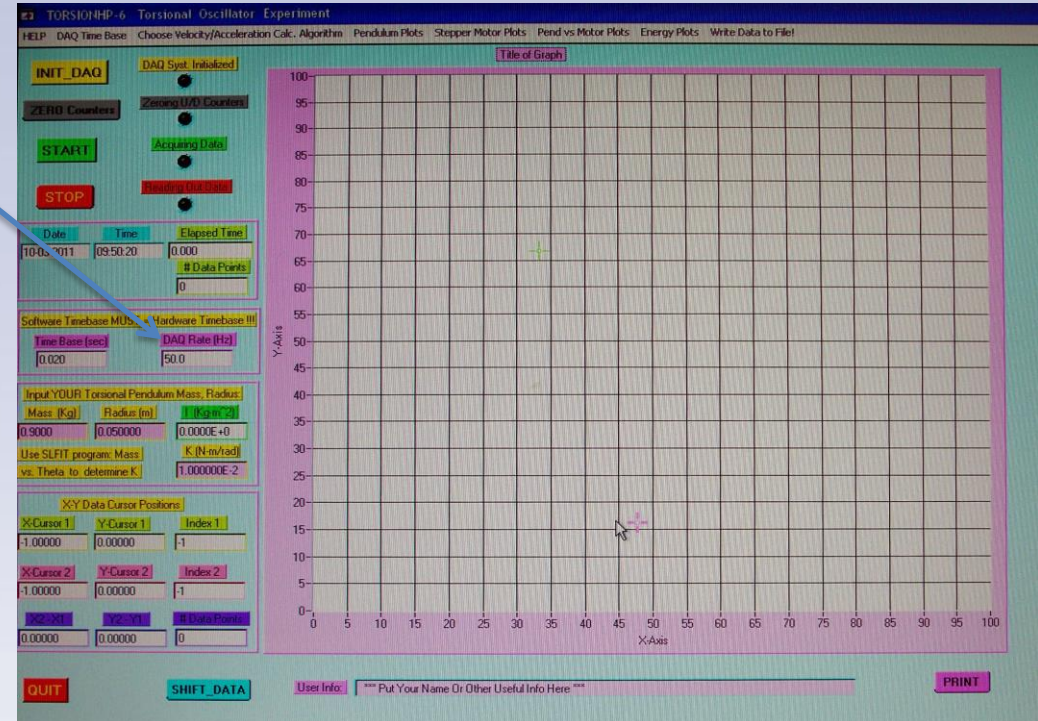
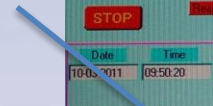

Interface card

Program window

Program can accept only 10000 points. If sampling rate is 50Hz – the maximum time of data collection is 200s!



Measuring of the Torsional Spring constant.

$$\vec{\tau}_1 + \vec{\tau}_2 = 0 \longrightarrow K\theta = mgR$$

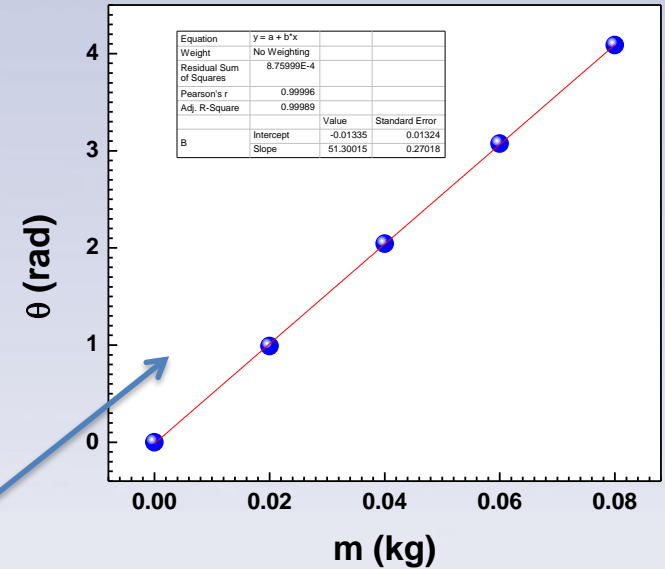
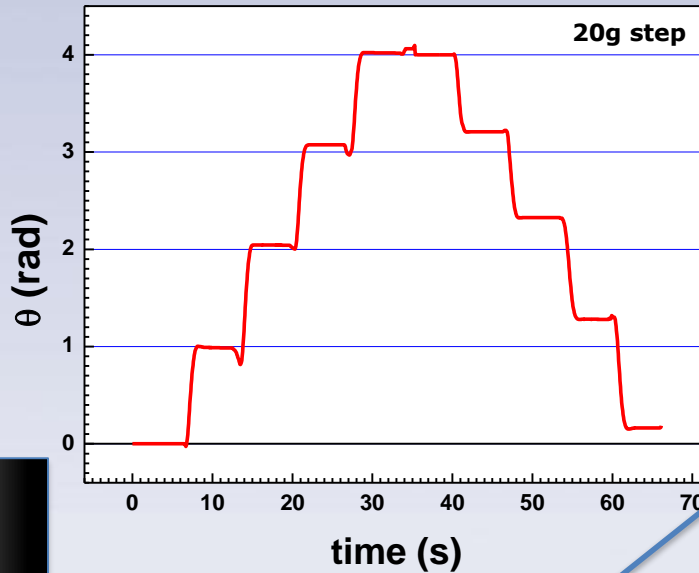
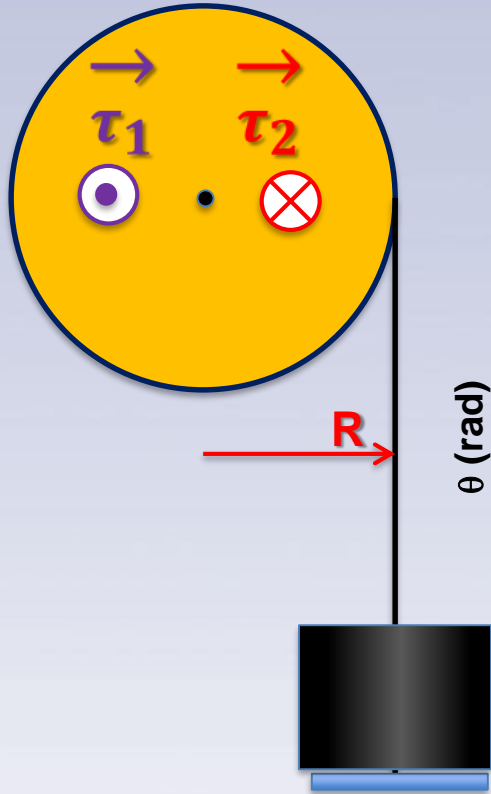

slope

$$\theta = \frac{gR}{K} m \quad K = \frac{gR}{\text{slope}}$$

$g=9.81\text{m/s}^2$
Slope=51.3rad/kg
 $K=0.00971\text{Nm/rad}$



Measuring of the Torsional Spring constant. Possible problems.

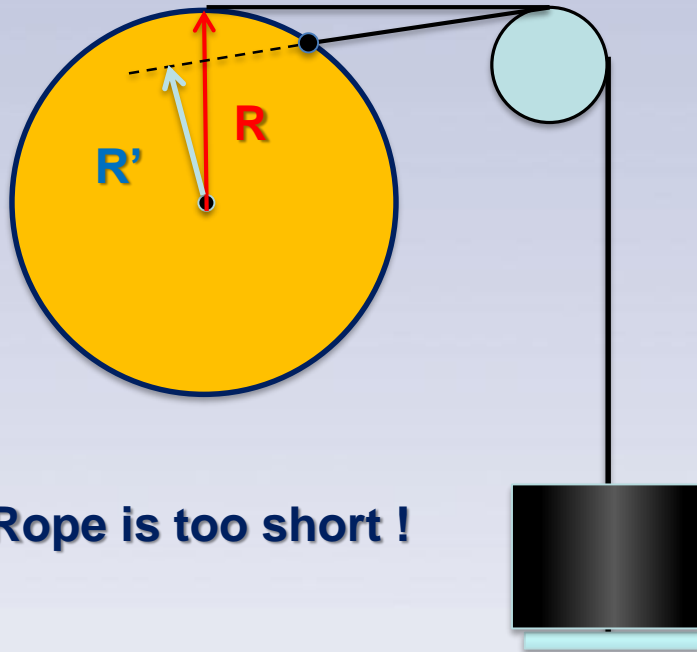

$$\tau = R \times F$$

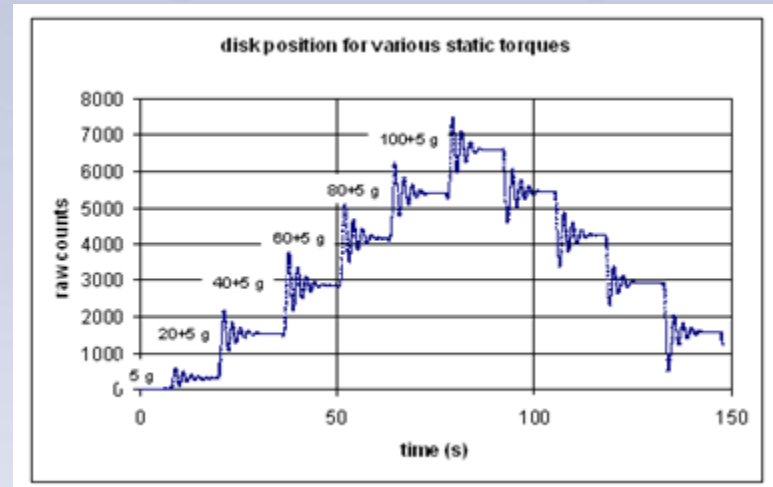

Avoid the over damping of the pendulum motion and any extra sources of friction.



Torsional Pendulum. Scientific application.

Measuring of the electrostatic forces.



Charles-Augustin de Coulomb
1736-1806

$$\vec{\tau}_1 + \vec{\tau}_2 = 0$$

$$K\theta = FL;$$

Where F is electrostatic force and L is the length of the balance beam.

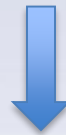

Coulomb's law

$$F = k_e \frac{q_1 * q_2}{r^2}; \quad k_e = \frac{1}{4\pi\epsilon_0}$$

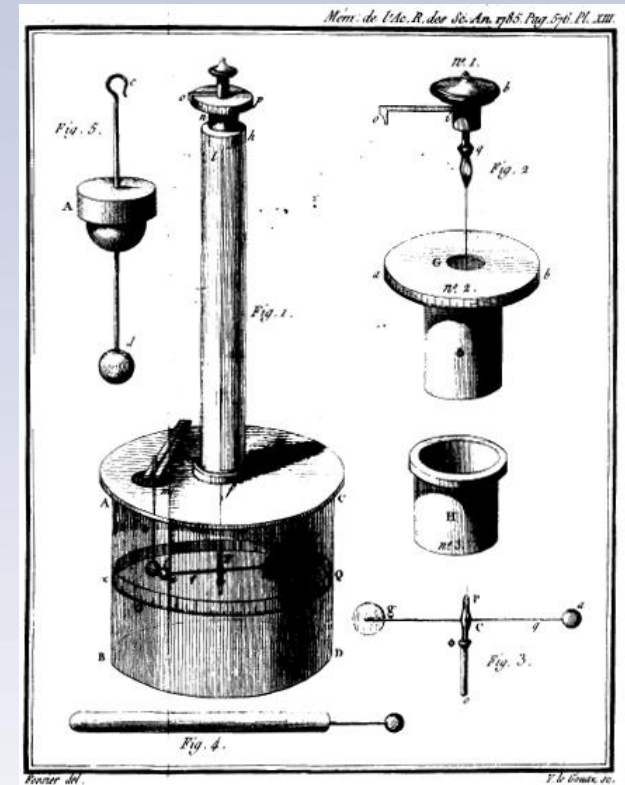

Coulomb's torsion balance.

Courtesy of Wikipedia



Torsional Pendulum. Scientific application.



Henry Cavendish
(1731–1810)

Gravitational
Law

$$F = \frac{GmM}{r^2}$$

Cavendish's result



illinois.edu

10/7/2019

Measuring of the gravitational forces.

$$\vec{\tau}_1 + \vec{\tau}_2 = 0$$

$$K\theta = FL;$$

Where F is gravitational force and L
is the length of the balance beam.

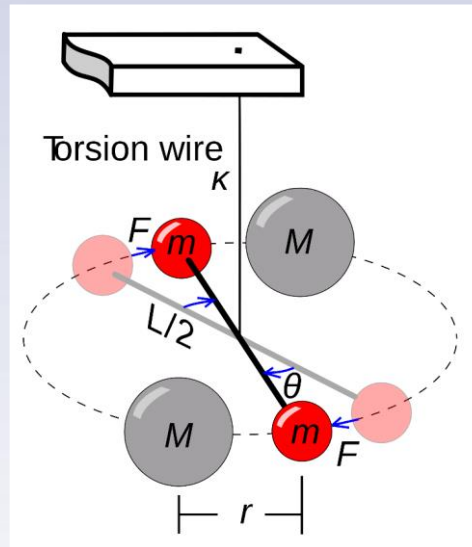

Cavendish torsion
balance experiment.

Courtesy of Wikipedia

Currently accepted value

$$6.67428 \times 10^{-11} \text{ m}^3 \text{ kg}^{-1} \text{ s}^{-2}.$$

The Torsional Oscillator. “No damping”.

$$\tau = \tau_1 + \tau_2 = -K_1\theta - K_2\theta = -K\theta$$

$$K_1 = \frac{\pi Gr^4}{2L_1}; \quad K = K_1 + K_2 = \frac{\pi Gr^4}{2} \left(\frac{1}{L_1} + \frac{1}{L_2} \right)$$

If there is no dissipation:

$$I \frac{d^2\theta}{dt^2} = -K\theta$$

Solution: $\theta = \theta_0 \sin(\omega_0 t + \phi)$ with $\omega_0 = \sqrt{\frac{K}{I}}$

If we know **I** we can calculate **K**

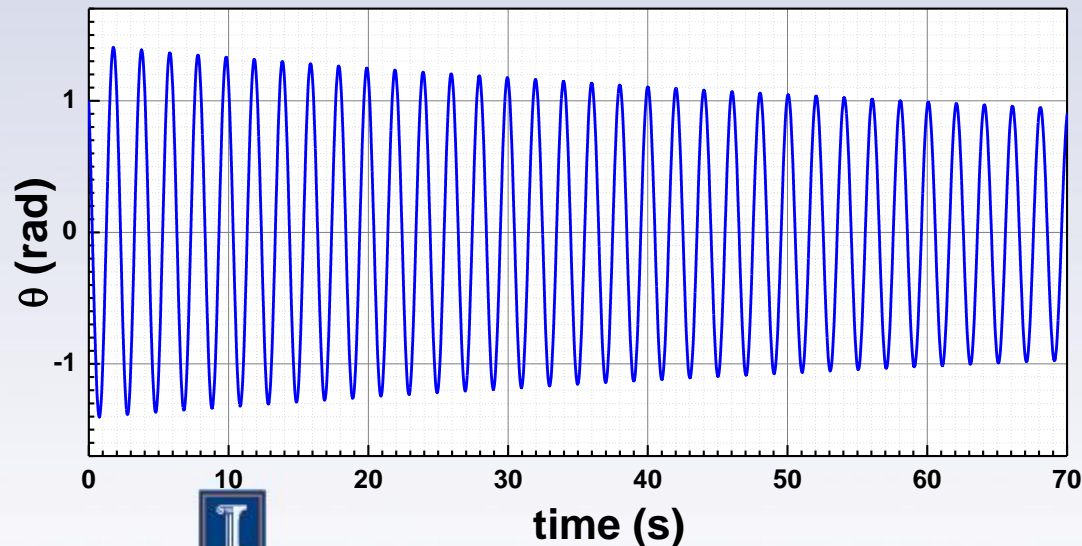

From time trace $\theta(t)$ we can find ω_0 it can be done by measuring period but better (and faster!) to perform the nonlinear fitting.

The Torsional Oscillator. "No damping". Fitting

"No damping" is not realistic situation fitting should be done to

SineDamp function $y = y_0 + A \exp\left(\frac{-x}{t_0}\right) \sin\left(\pi \frac{(x-x_c)}{w}\right)$ $\omega_0 = \frac{\pi}{w}$

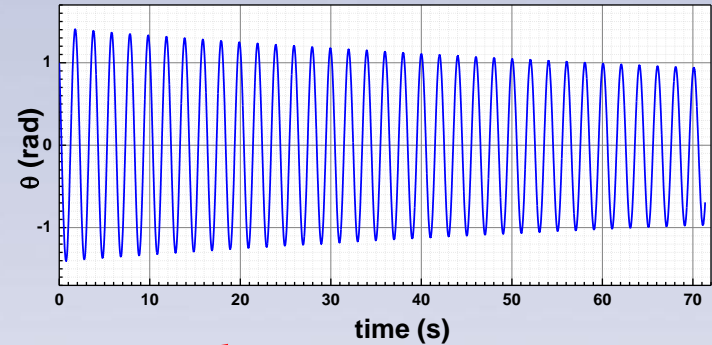
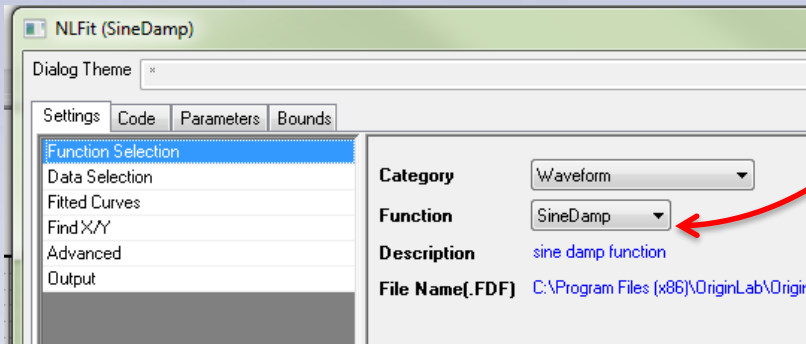

$$\omega_0 = 3.126 \frac{\text{rad}}{\text{s}}; f_0 = \frac{\omega_0}{2\pi} \approx 0.4975 \text{ Hz}$$

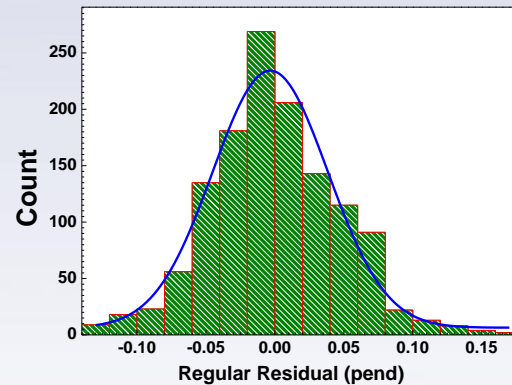
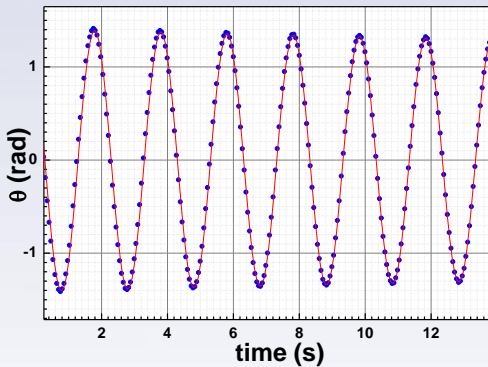

SineDamp: $y = y_0 + A \exp\left(\frac{-x}{t_0}\right) \sin\left(\pi \frac{(x-x_c)}{w}\right)$		
	Value	Standard Error
y0	-0.0024	0.0013
xc	-0.7236	9.3E-4
w	1.00517	2.5E-5
t0	178.02	2.44
A	1.409	0.004

$$K = \omega_0^2 I \approx 1.12 \times 10^{-2} \frac{\text{Nm}}{\text{rad}}$$



The Torsional Oscillator. "No damping". Fitting.

$$\omega_0 = \frac{\pi}{w} \quad f_0 = \frac{1}{2w}$$

From "SineDamp fitting $f_0=0.497\text{Hz}$
or $\omega_0 = 2\pi f_0 = 3.123\text{rad / s}$

Resonance frequency can be also found
by applying FFT on the raw data

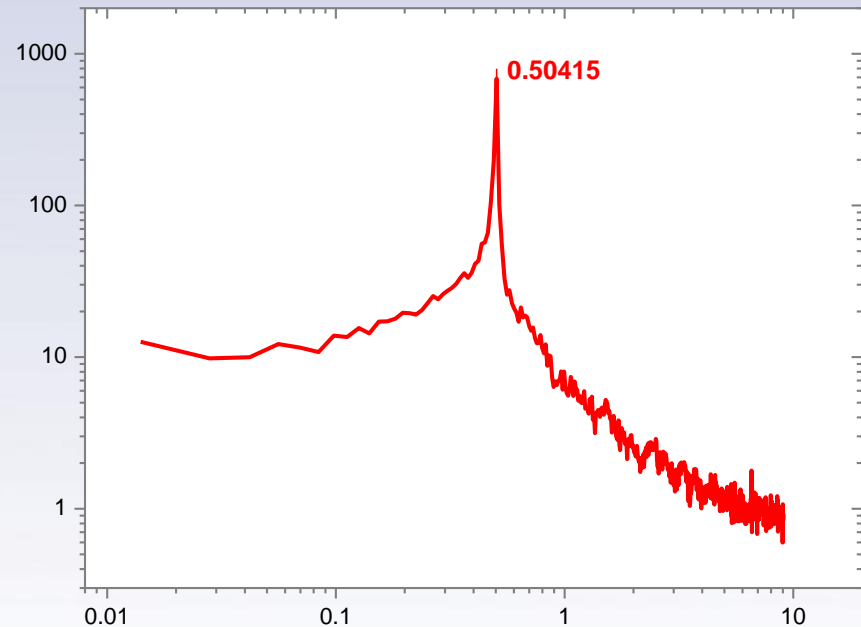
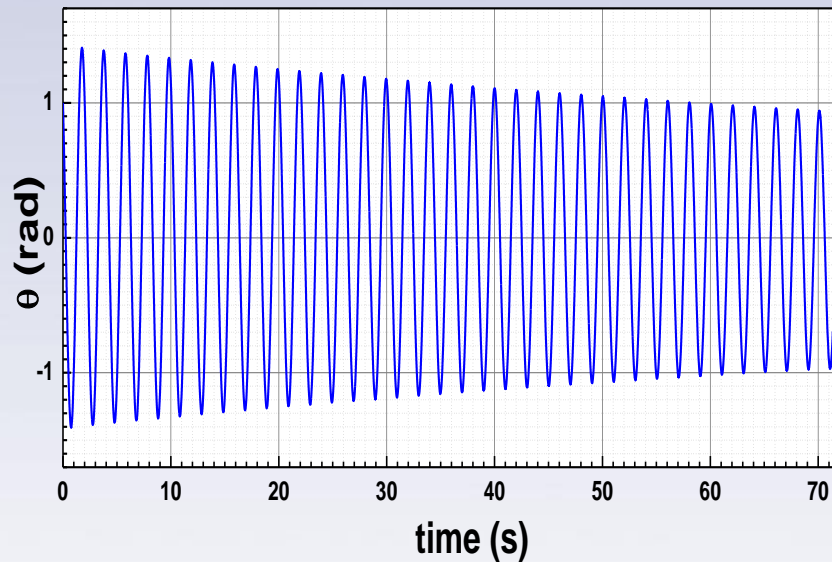

Three different kinds of mechanisms.

1.Viscous (magnetic) damping

2.Coulomb damping

3.Turbulent damping



Three different kinds of mechanisms.

1. Viscous (magnetic) damping

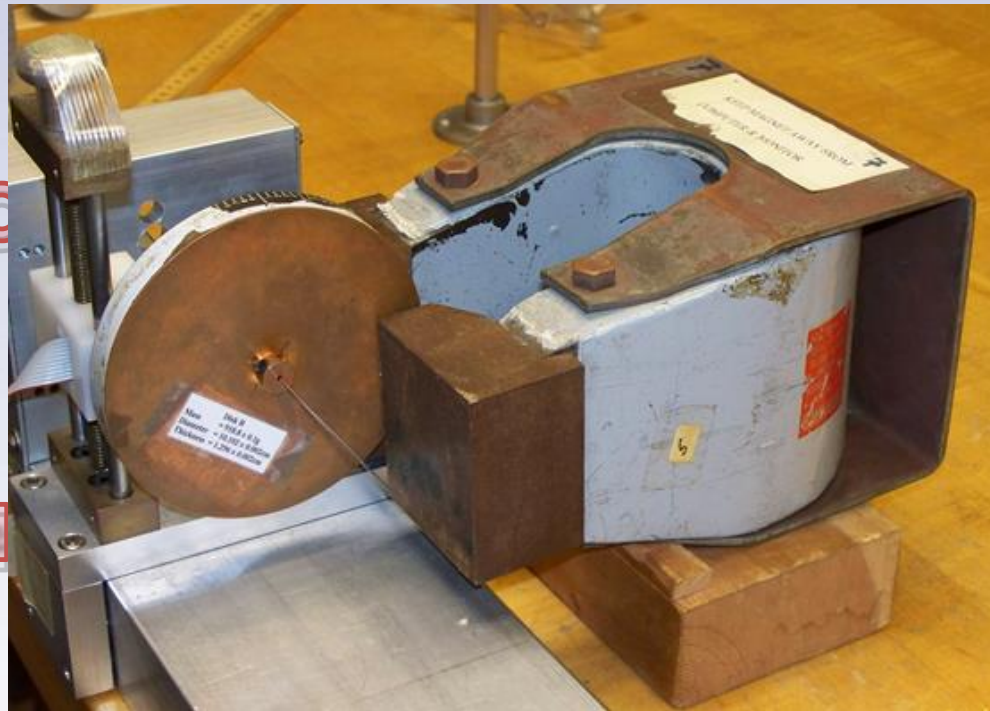

2. Co

3. Tu



Viscous (magnetic) damping.

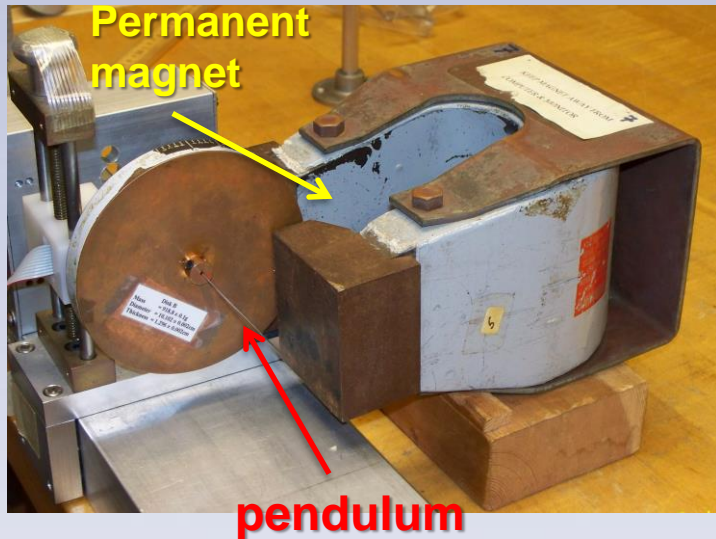

$$I \frac{d^2\theta}{dt^2} + K\theta + R \frac{d\theta}{dt} = 0$$

Damping term

The solutions are exactly the same as in case of RLC circuit (three solutions)

Under damped case

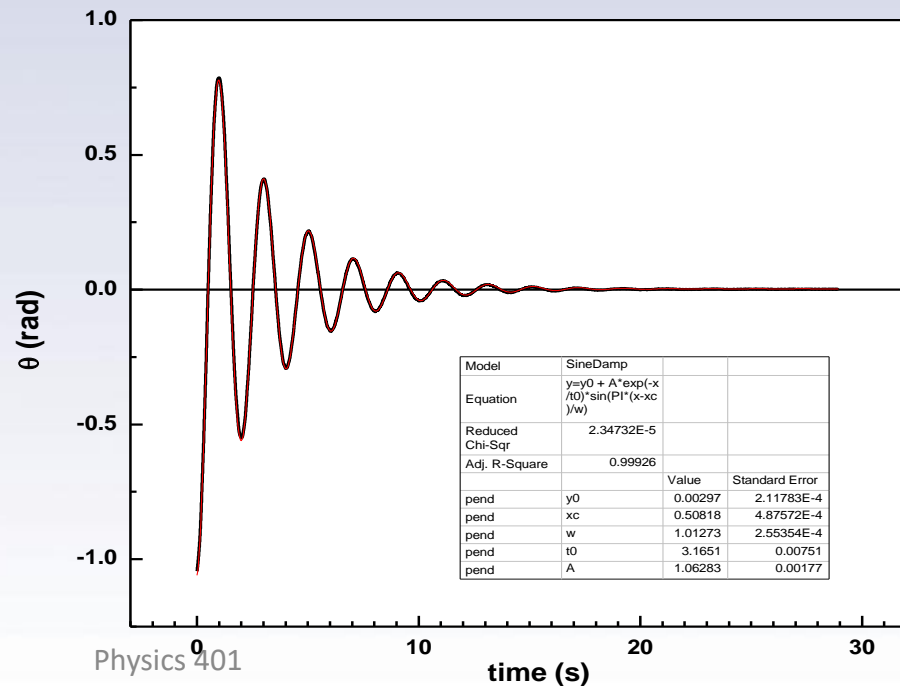

Viscous damping. Logarithmic decrement.

$$I \frac{d^2\theta}{dt^2} + K\theta + R \frac{d\theta}{dt} = 0$$

$$\delta = \ln\left(\frac{\theta_{n+1}}{\theta_n}\right);$$

For viscous damping $\delta = \frac{T}{t_0}$;

where

T – period and **t₀** – characteristic decay time*

from SineDamp fitting function

$$T=2w \text{ and } \delta = \frac{2w}{t_0}$$

$\delta = 0.640 \pm 0.002$ ← from error propagation analysis

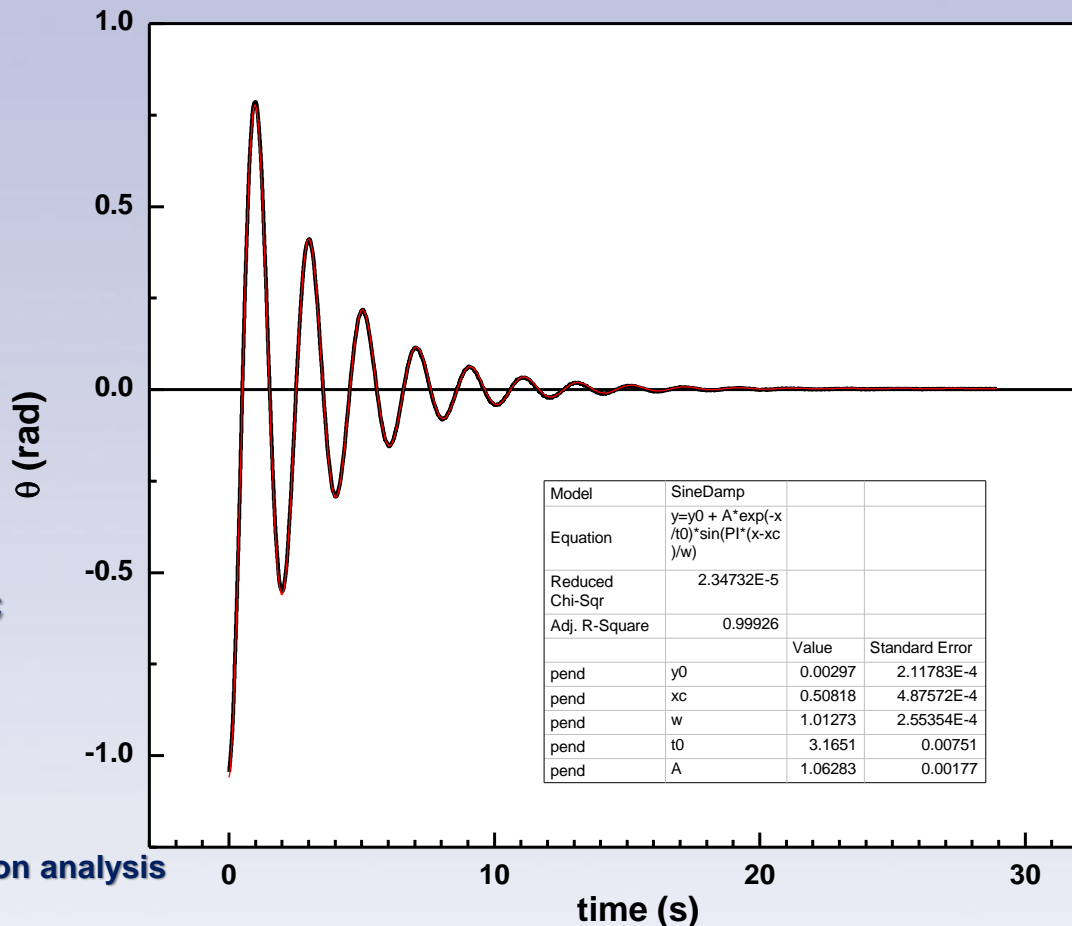

From SineDamp fitting exponential decay term is $\exp\left(\frac{-t}{t_0}\right)$

* $a = \frac{1}{t_0}$ (write up)



Viscous damping. Logarithmic decrement.

We can find the amplitudes of the wave using Peak Analyzer

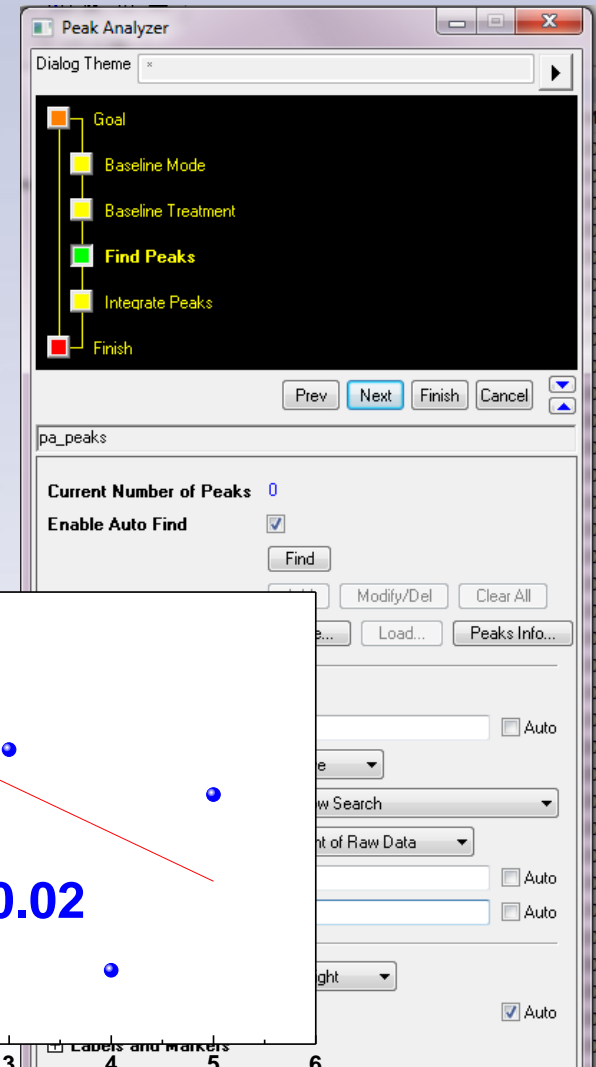
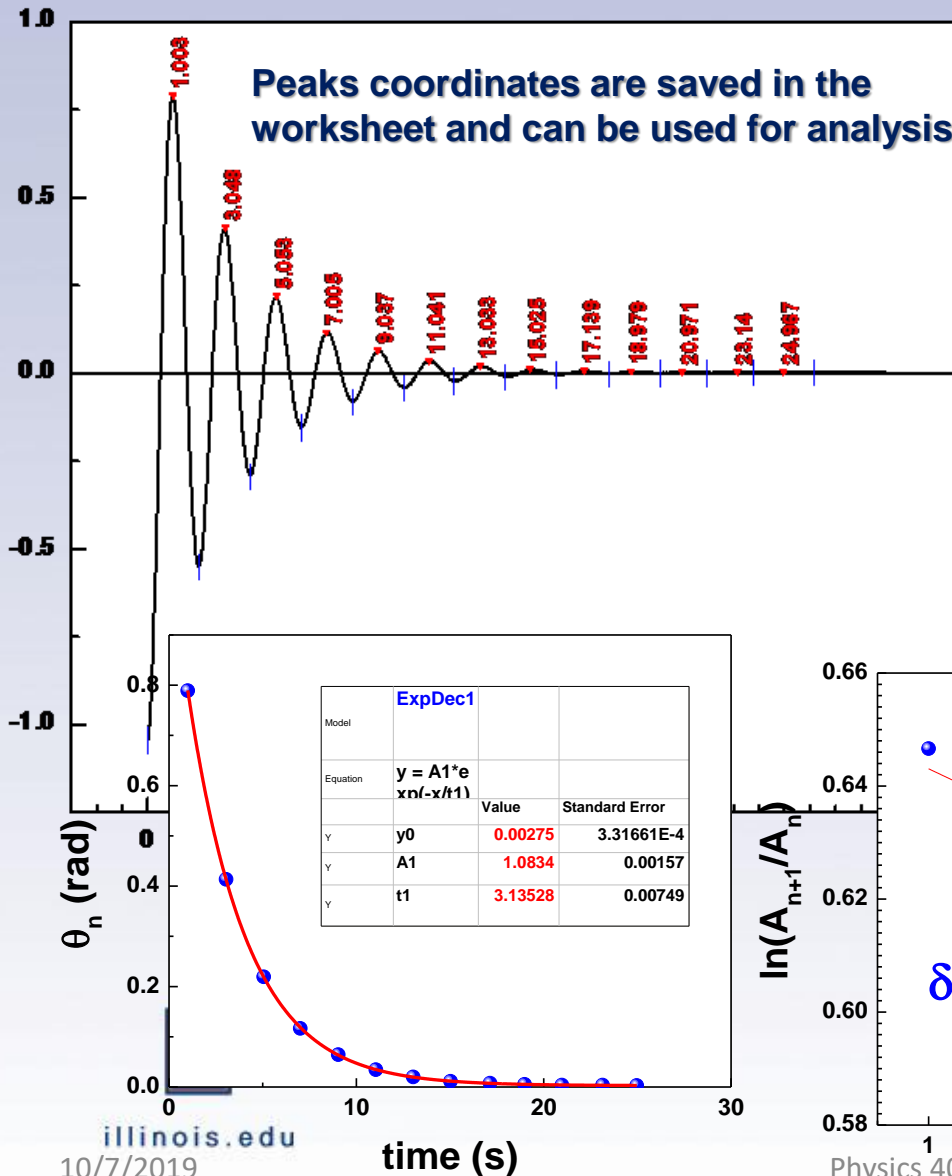

Analysis. 1

1. Fitting to damp exponential decay function. Outcome: **resonance frequency** and **decrement coefficient** .
2. Applying FFT procedure. Result – **resonance frequency**.
3. Using Origin Peak Analyzer we can find **amplitudes and positions** of the damped sine wave maximum end then plot the envelope.
4. You can directly obtain the **envelope** of the damped sine wave by using Origin (optional).



Three different kinds of mechanisms.

1.Viscous (magnetic) damping

2.Coulomb damping

3.Turbu

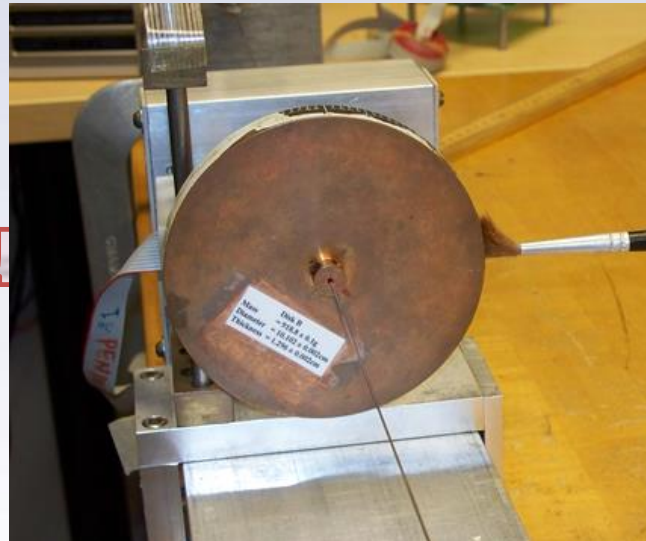

Coulomb damping. Theory

$$I\ddot{\theta} + K\theta + \tau_{Coulomb} = 0$$

$$\tau_{Coulomb} = C \frac{|\dot{\theta}|}{\dot{\theta}}$$

Amplitude decreases by $4C/K$ per period linearly !

$$\theta(t) = +C/K + (\theta_0 - (4n-1)C/K) \cos(\omega t)$$

$$(n - \frac{1}{2})T \leq t \leq nT \quad n = 1, 2, \dots$$

$$\theta(t) = +C/K + (\theta_0 - (4n-3)C/K) \cos(\omega t)$$

$$(n-1)T \leq t \leq (n - \frac{1}{2})T \quad n = 1, 2, \dots$$

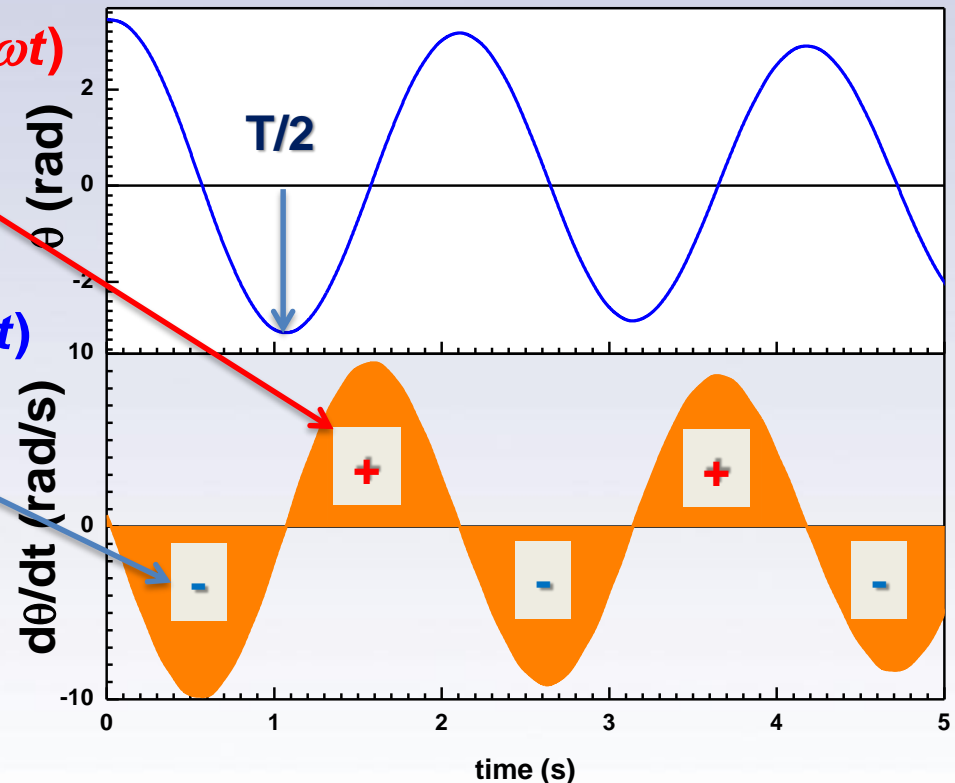

Coulomb damping. Experiment

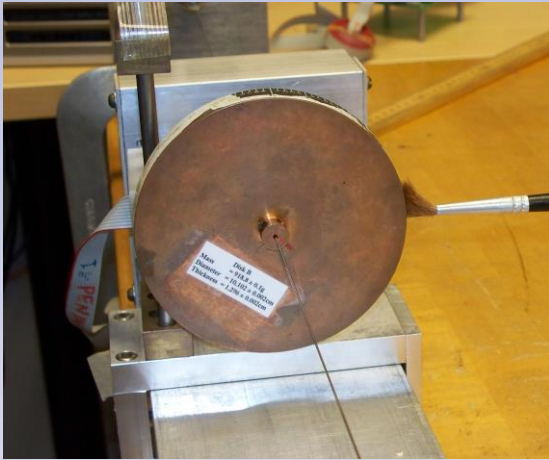

Amplitude decreases by $4C/K$ per period linearly !

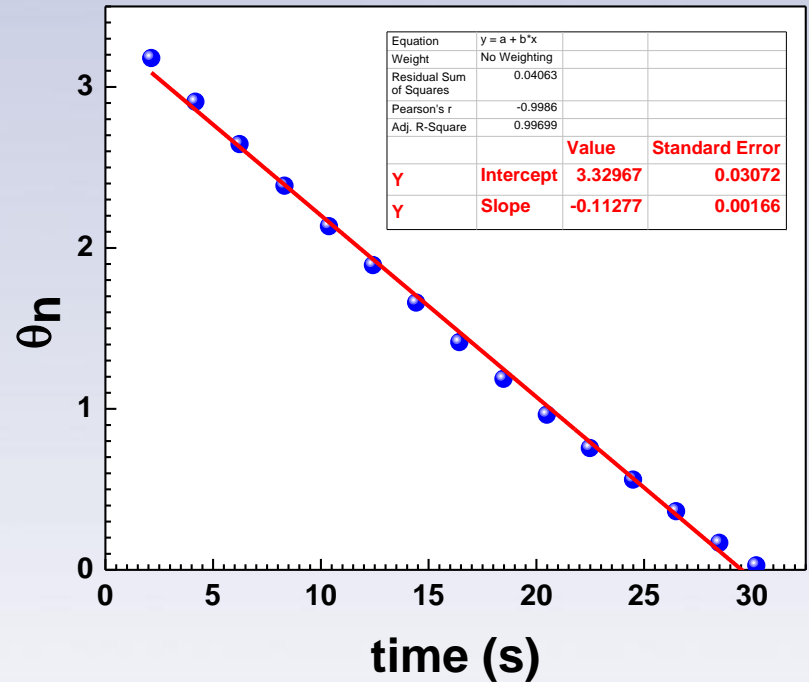
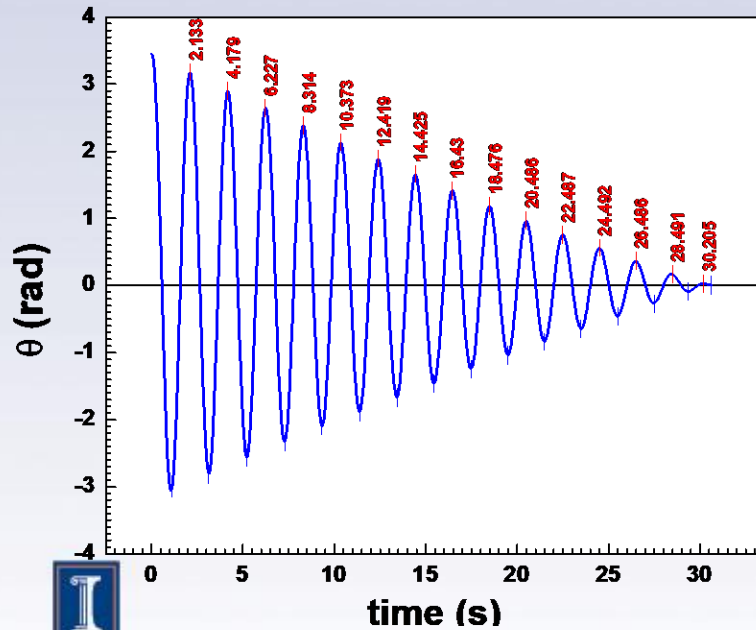

Coulomb damping. Experiment

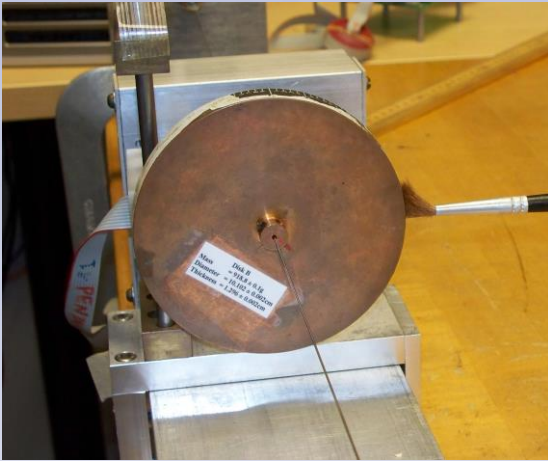

$$|\tau_{\text{Coulomb}}| = C$$
$$K\theta \sim \theta$$

if $K\theta \leq C$
pendulum stops

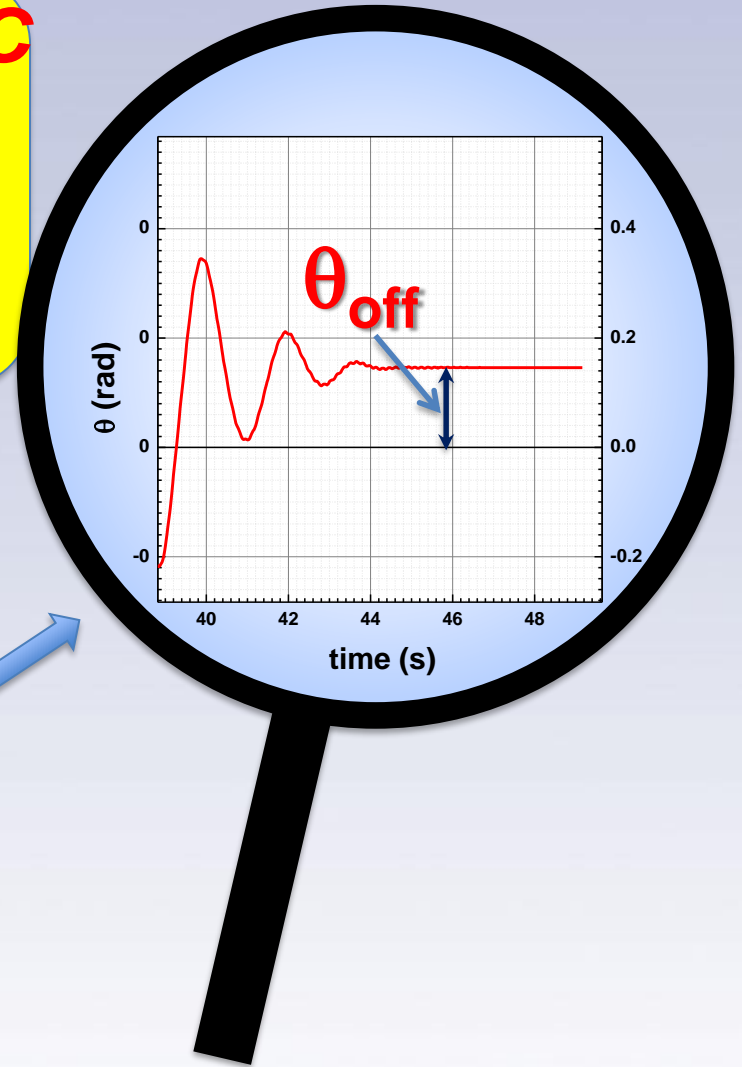
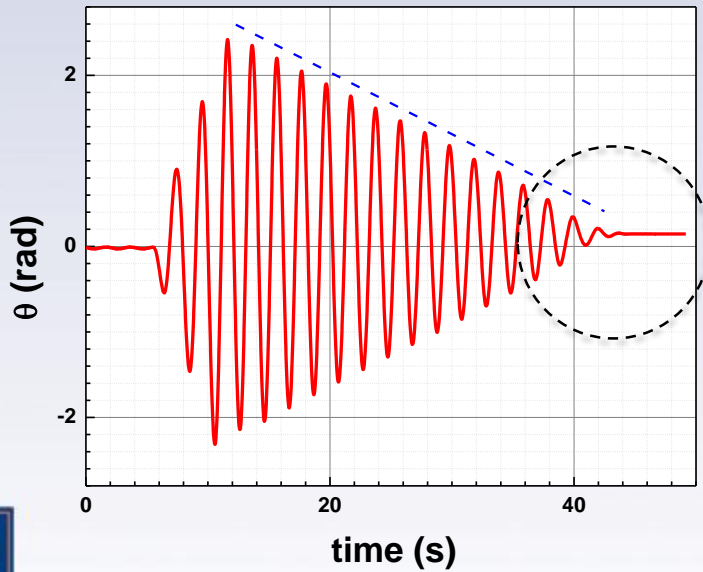

Three different kinds of mechanisms.

1.Viscous

damping

2.Coulomb

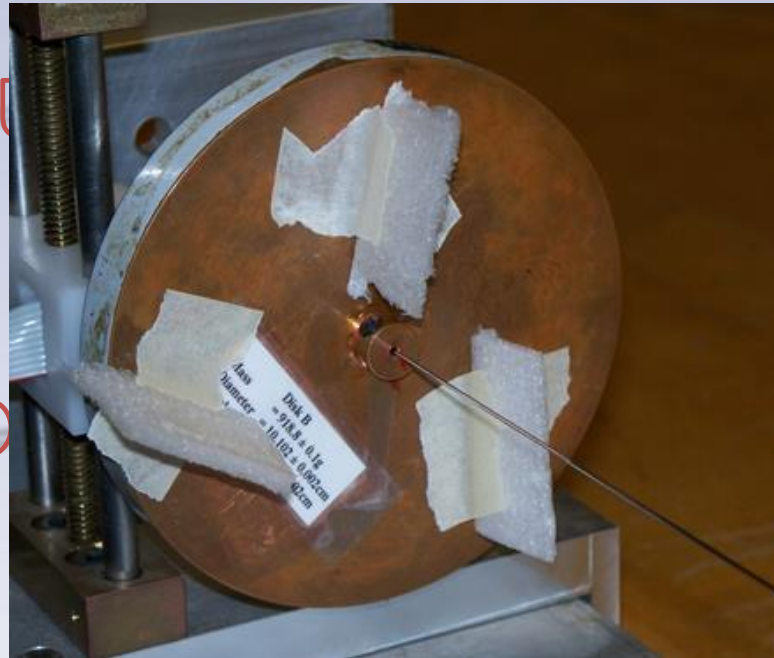

3.Turbulent damping



Turbulent damping. Theory

$$I\ddot{\theta} + K\theta + \tau_{Turb} = 0$$

$$\tau_{turb} = C_t \operatorname{sgn}(\dot{\theta}) |\dot{\theta}|^n$$

In case of $n=1 \rightarrow$ viscous damping

Logarithmic decrement in case of turbulent damping is no more constant and in case $n=2$ can be calculated as $\delta =$

$$\frac{8C}{3I} \theta_0$$

Expected result – decrement decreases with decreasing of the amplitude



Turbulent damping. Experiment

Analyzing the envelope of the damped oscillating time record we can calculate the log decrement factor

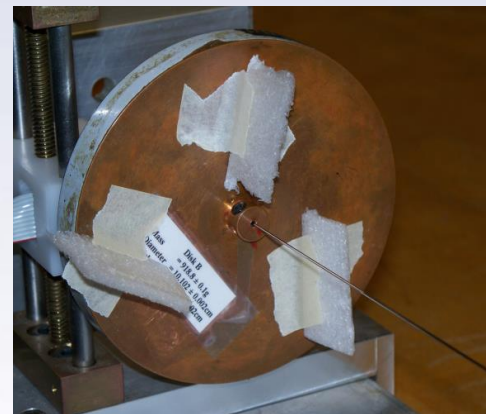
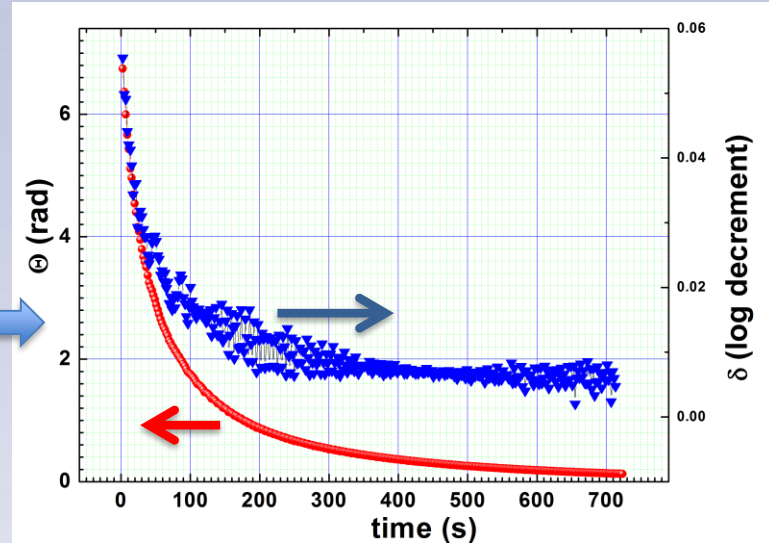
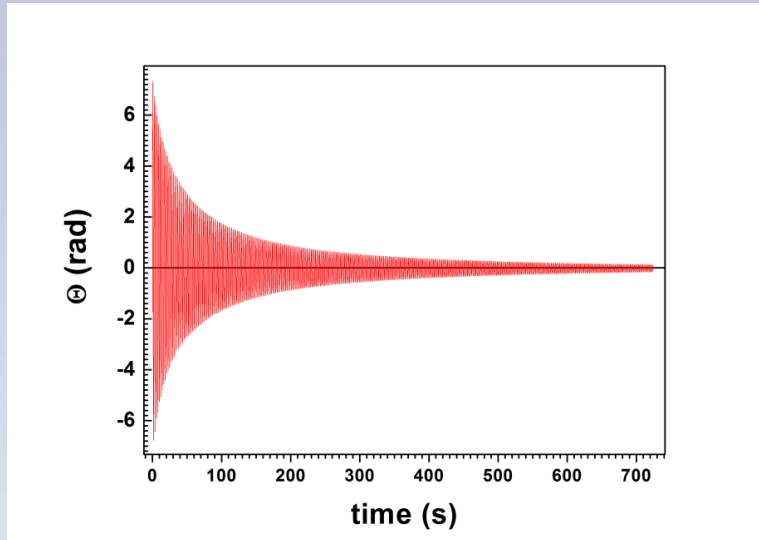

Turbulent damping. Experiment.

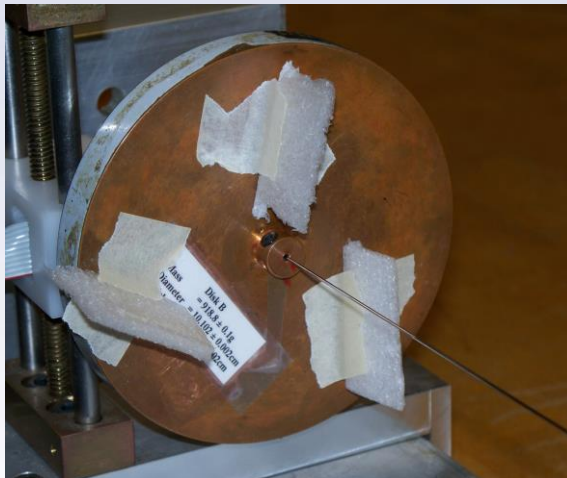
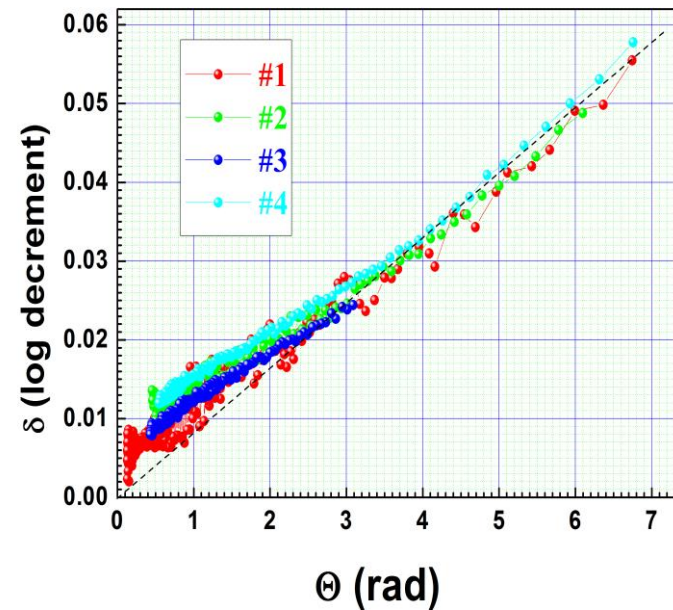
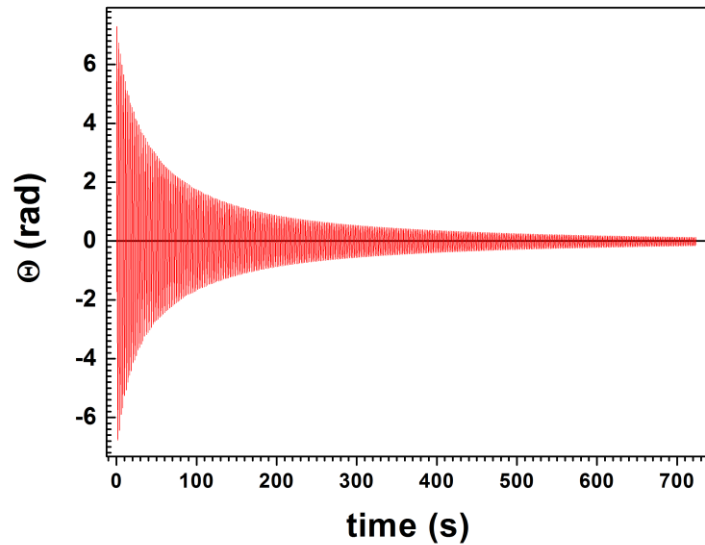

Data analysis. Finding the peaks.

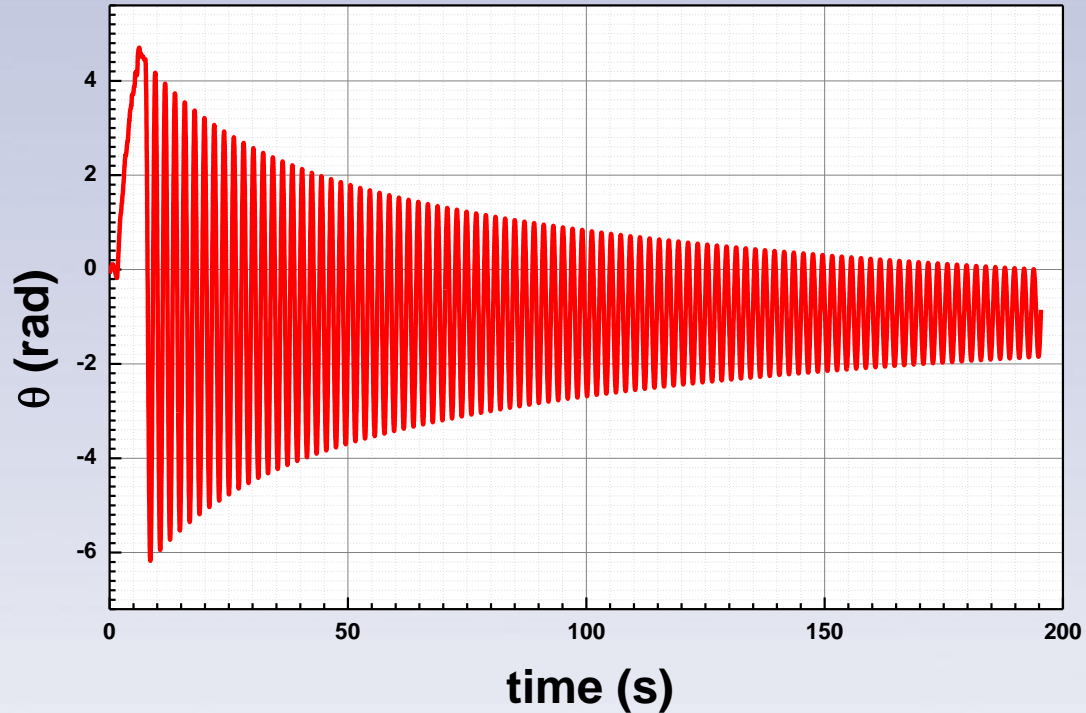

Raw data.

Our goal: find the positions and amplitudes of the peaks

X_i, Y_i

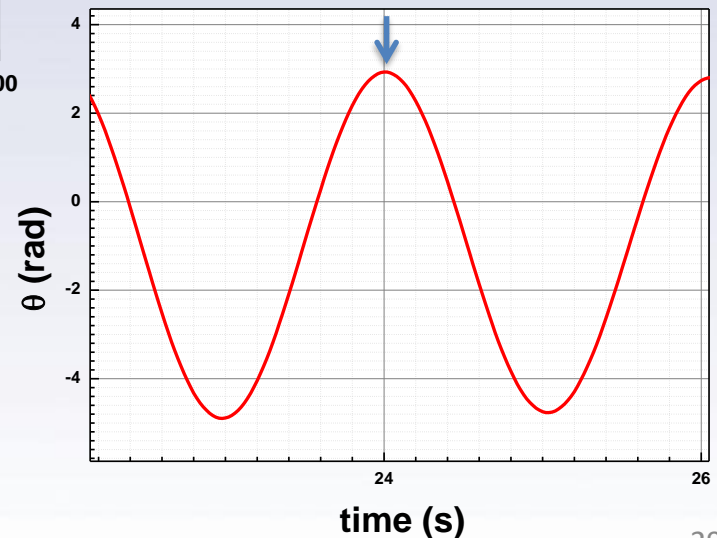

1st Technique: using “*FindPeaks*” option



Data analysis. Finding the peaks.

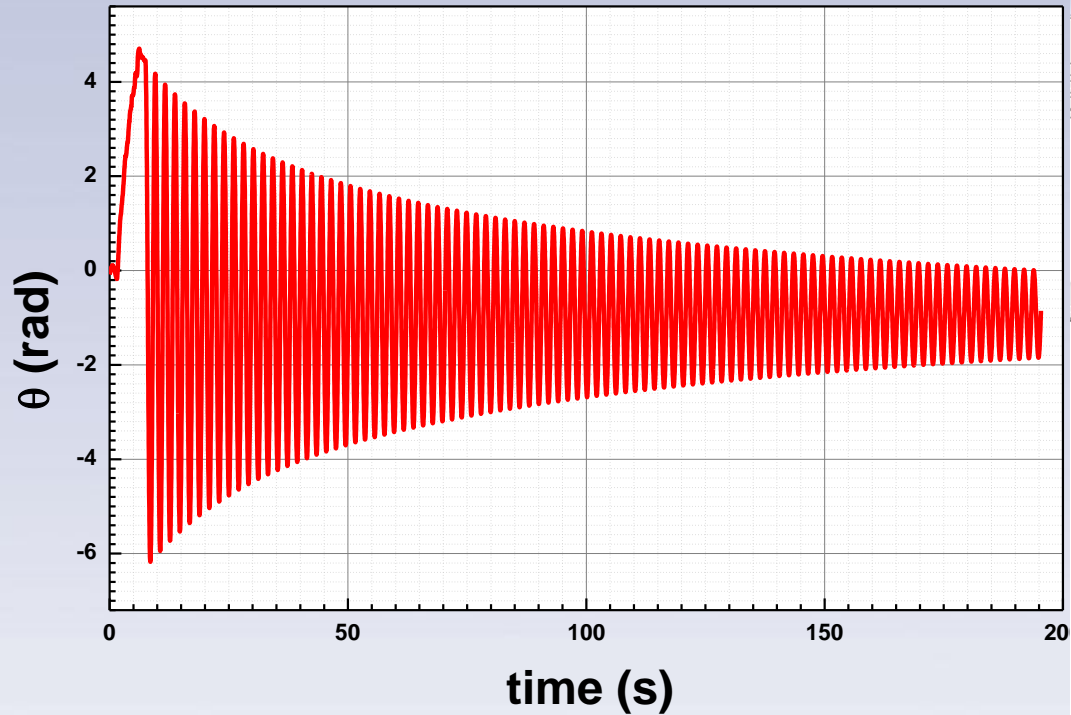

Peak Analyzer

Dialog Theme

- Goal
- Baseline Mode
- Baseline Treatment
- Find Peaks**
- Integrate Peaks
- Finish

pa_peaks

Current Number of Peaks 0

Enable Auto Find

Find

Add Modify/Del Clear All

Save... Load... Peaks Info...

Peak Finding Settings

Show 2nd Derivative

Smoothing Window Size 0 Auto

Direction Positive

Method **Local Maximum**

Local Points

- Local Maximum
- Window Search
- 1st Derivative
- 2nd Derivative (search Hidden peaks) (Pro)
- Residual after 1st Derivative (search Hidden peaks) (Pro)

Peak Filtering

Method

Threshold Height(%) 20 Auto

Labels and Markers

Local Maximum works well for not noisy oscillating dependencies



Data analysis. Finding the peaks.

The details related to this project you can find in:

\\engr-file-03\PHYINST\APL Courses\PHYCS401\Students\6. Torsional oscillator\Turbulent damping.opj

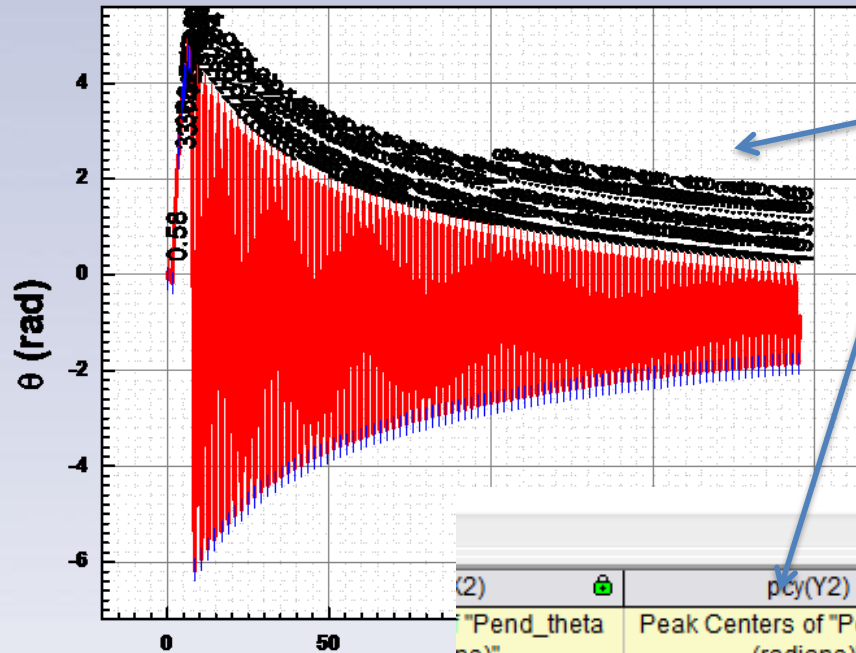

New plot + labels as a result of finding the peaks

“Peaks” data can be found in a **Worksheet** and using this data you can plot the dependence of amplitude on time

(2)	pcy(Y2)	pmx(X3)	pmy(Y3)
"Pend_theta (radians)"	Peak Centers of "Pend_theta (radians)"	Base Markers of "Pend_theta (radians)"	Base Markers of "Pend_theta (radians)"
t	Y	X	Y
0.58	0.10738	0	-0.0813
3.36	2.44056	1.54	-0.17948
3.76	2.72742	1.54	-0.17948
4.54	3.4829	3.44	2.42676
		3.44	2.42676
			2.128
4.88	3.72834		2.128
5.1	3.87177	4.54	3.4829
5.16	3.87253	4.54	3.4829

“Positive” peaks

“Negative” peaks



Data analysis. Finding the peaks.

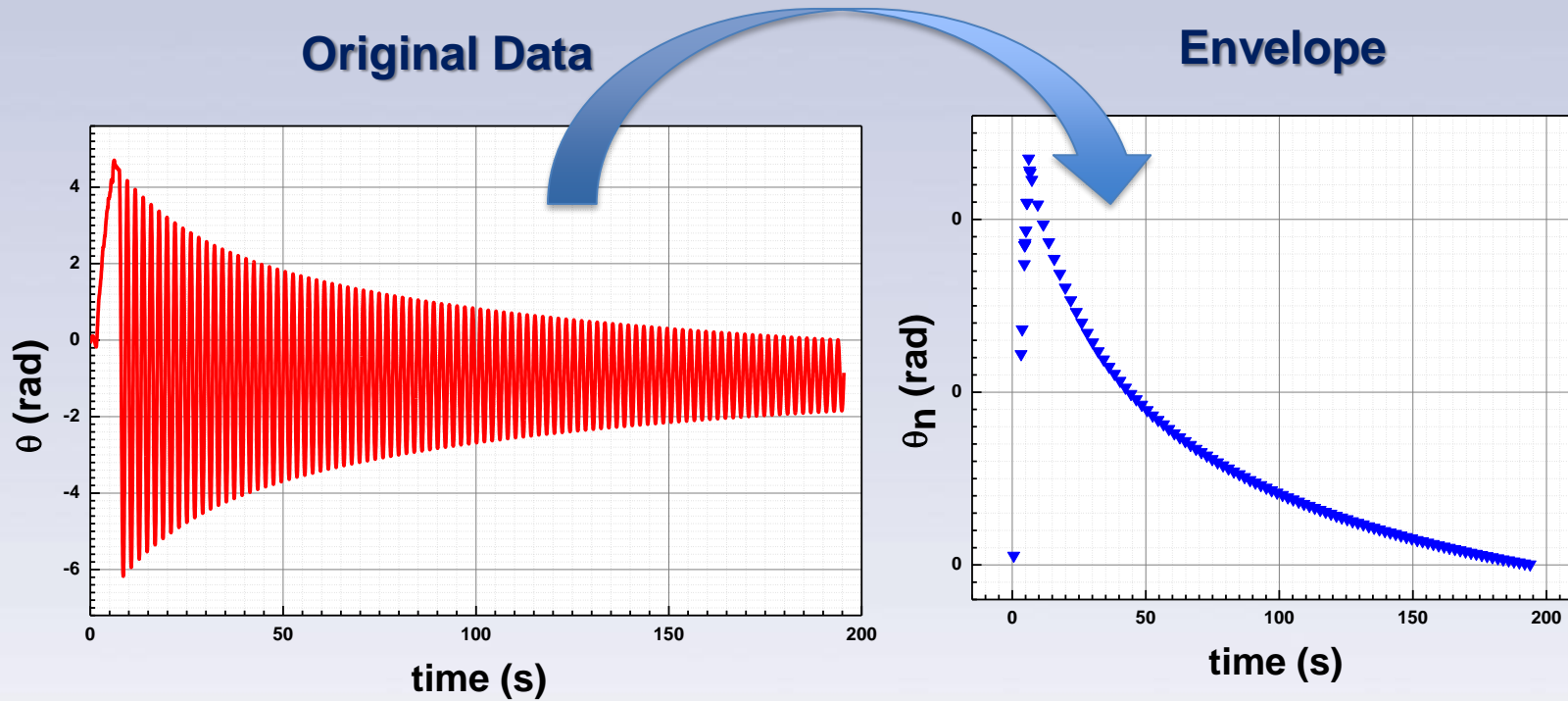

Data analysis. Finding the peaks.

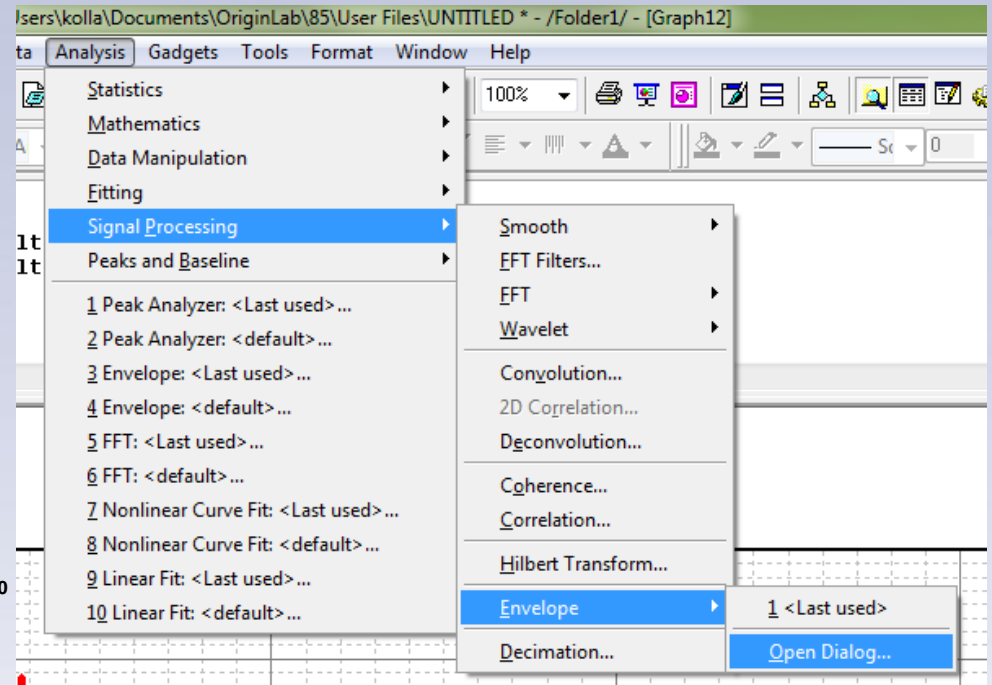
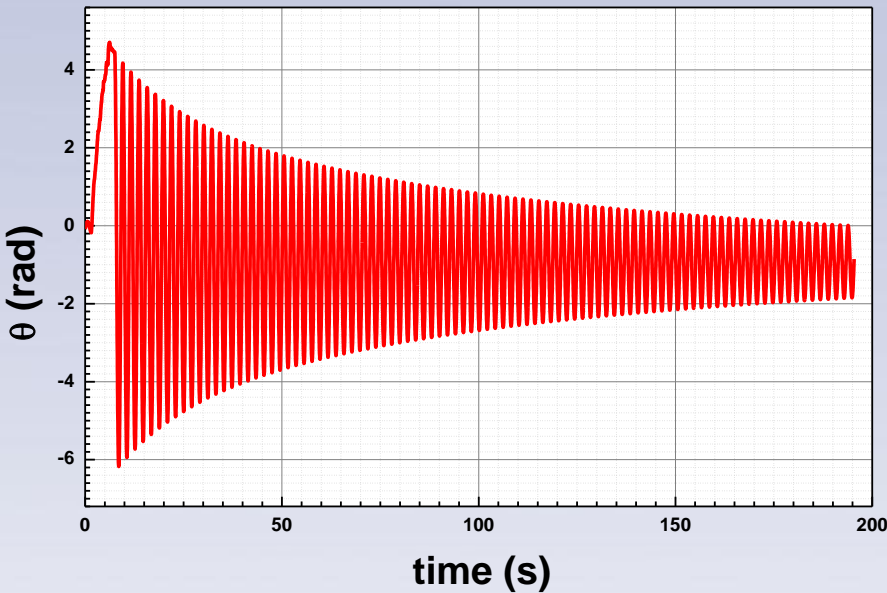

2nd Technique: using “*Envelope*” option

Origin will create the worksheet with interpolated (defined for the same x's as the raw data) “envelope” data



Data analysis. Finding the peaks.

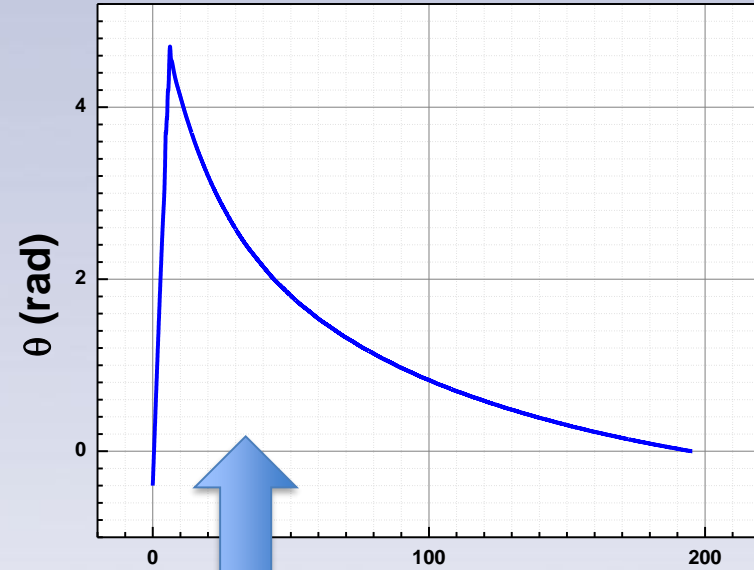
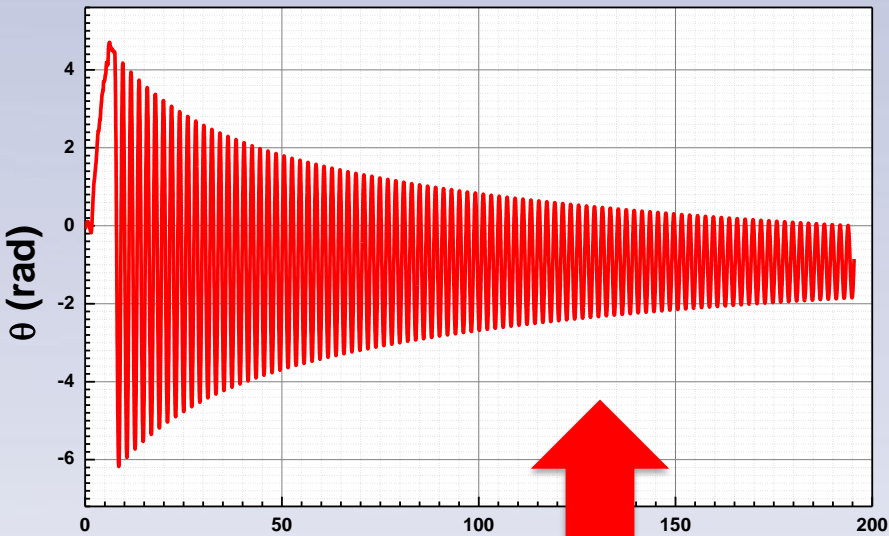

	A(X1)	B(Y1)	C(Y1)	X1(X2)	time (s)
ts				Upper Envelope of "Pend_theta (ra	Upper Envelope of "Pend_theta (radians)"
ie	Time	Pend_theta (radians)	Motr_theta (radians)	Envelope X 1	Envelope Y 1
1	0	-0.0813	0	0	-0.39883
2	0.02	-0.07286	0	0.02	-0.38144
3	0.04	-0.06443	0	0.04	-0.36403
4	0.06	-0.05522	0	0.06	-0.34662
5	0.08	-0.04679	0	0.08	-0.32921



Data analysis. FFT.

All these quasi periodic data can be analyzed using Fast Fourier Transform

Our goal: find the resonance frequency of the pendulum

Origin window

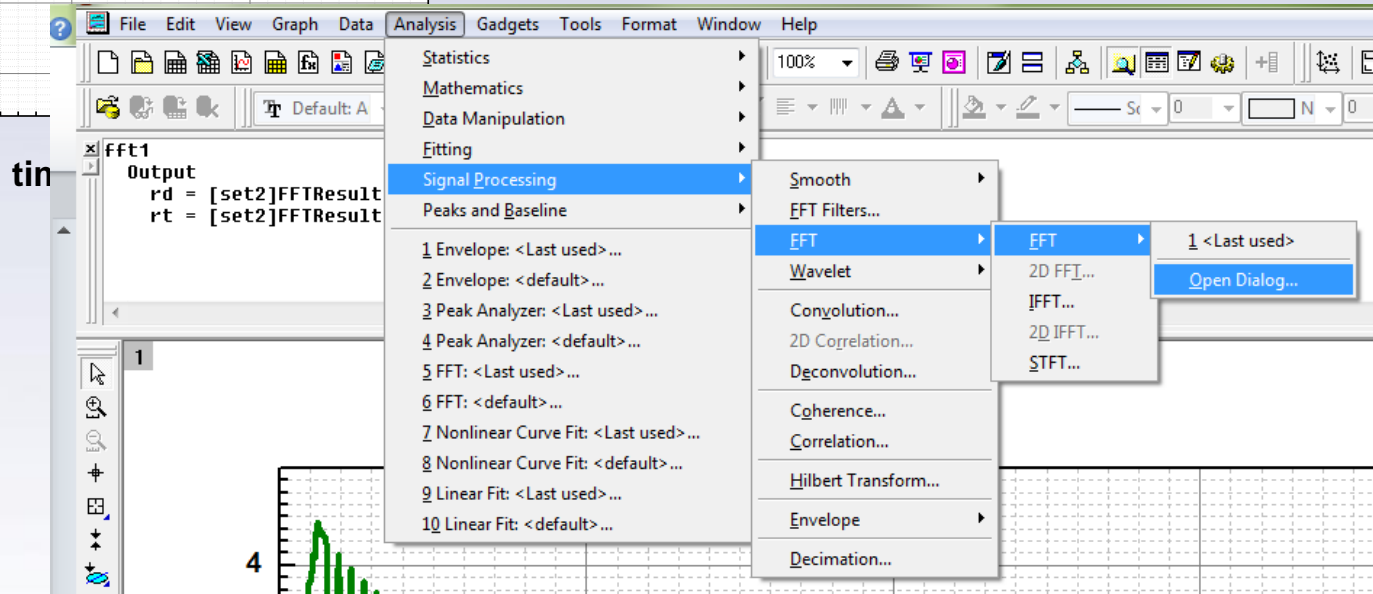
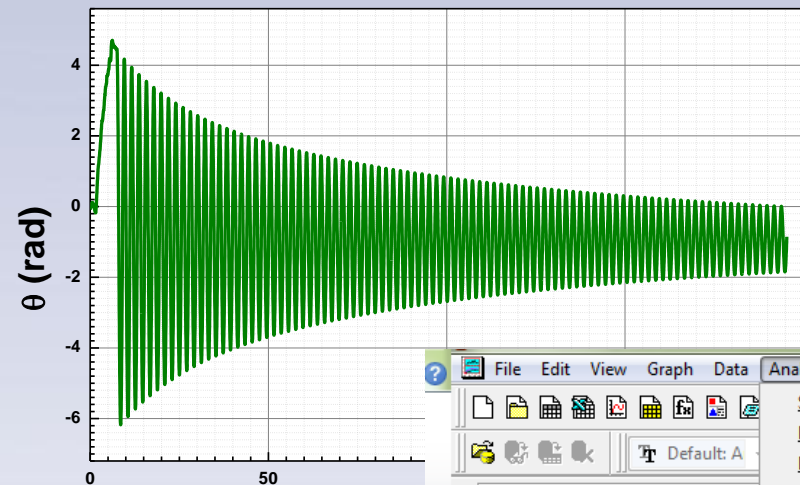

Data analysis. FFT.

The results of FFT you can find in the same Workbook which contains the raw data

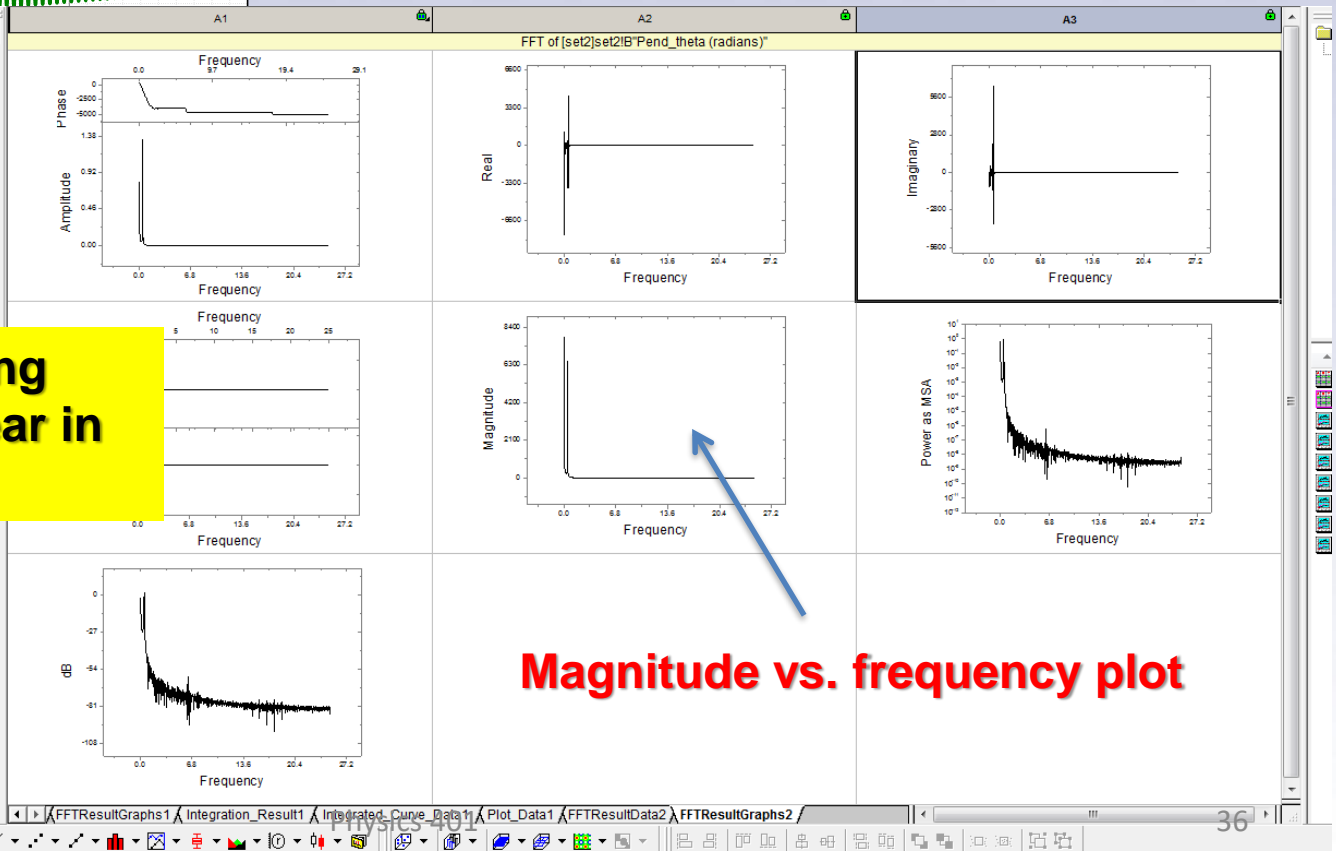
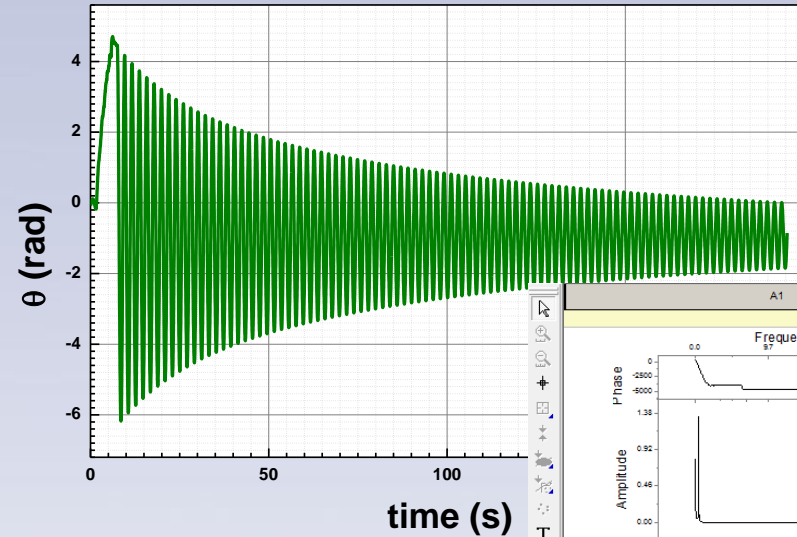

Click on corresponding graph and it will appear in separate window

Magnitude vs. frequency plot



Data analysis. FFT.

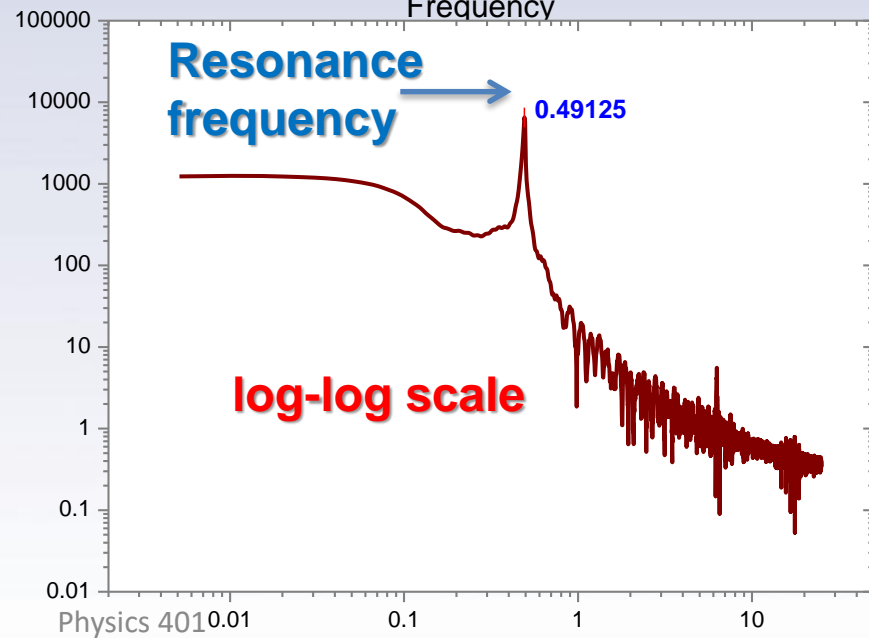
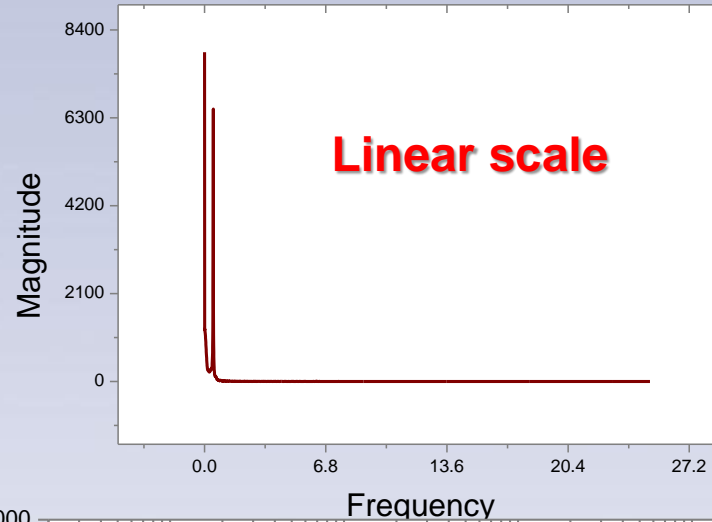
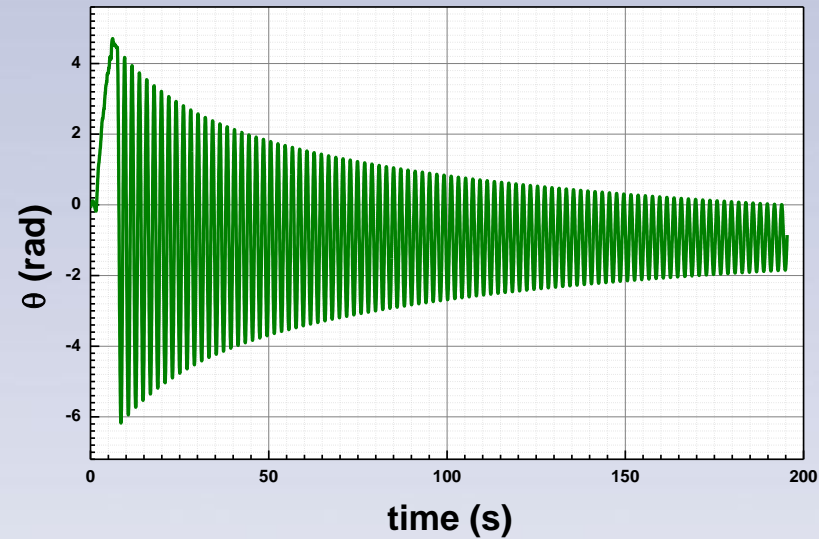

**Spectrum better to present
in log-log scale**



illinois.edu

10/7/2019

Physics 4010.01

0.1

1

10

37

Appendix. Some comments on oil drop experiment error analysis.

Result of measurement Systematic error

$$X_{\text{meas}} = X_{\text{true}} + e_s + e_r$$

Correct value

Random error

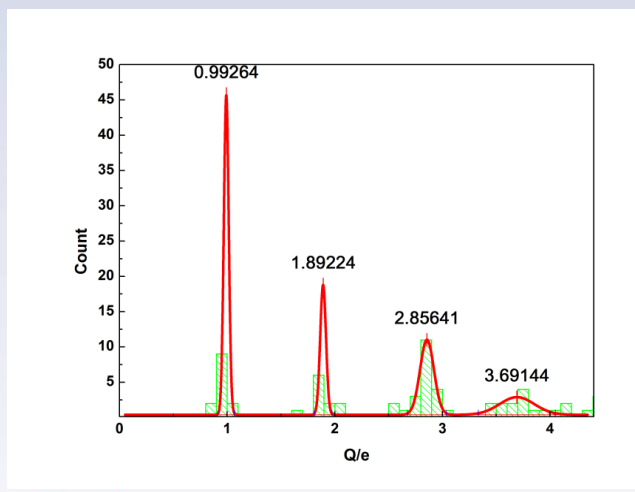
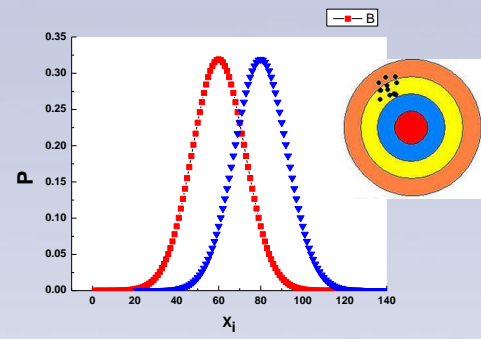

Appendix. Some comments on oil drop experiment error analysis.

Systematic error

$$X_{\text{meas}} \equiv X_{\text{true}} + e_s + e_r$$

$$Q = F \cdot S \cdot T = \left(\frac{1}{f_c^{3/2}} \right) \frac{9\pi d}{V} \sqrt{\frac{2\eta^3 x^3}{g\rho}} \frac{1}{\sqrt{t_g}} \left(\frac{1}{t_g} + \frac{1}{t_{\text{rise}}} \right)$$

$$F = \frac{1}{f_c^{3/2}} \approx 1 - \left(\frac{t_g}{\tau_g} \right)^{1/2}$$

$$S = \frac{9\pi d}{V} \sqrt{\frac{2\eta^3 x^3}{g\rho}}$$

$$T = \frac{1}{\sqrt{t_g}} \left(\frac{1}{t_g} + \frac{1}{t_{\text{rise}}} \right)$$

$$\Delta Q = \sqrt{\left(\frac{dQ}{dF} \right)^2 (\Delta F)^2 + \left(\frac{dQ}{dS} \right)^2 (\Delta S)^2 + \left(\frac{dQ}{dT} \right)^2 (\Delta T)^2} \approx \sqrt{\left(\frac{dQ}{dS} \right)^2 (\Delta S)^2 + \left(\frac{dQ}{dT} \right)^2 (\Delta T)^2}$$

$$= \sqrt{(FT)^2 (\Delta S)^2 + (FS)^2 (\Delta T)^2} = Q \sqrt{\left(\frac{\Delta S}{S} \right)^2 + \left(\frac{\Delta T}{T} \right)^2}$$



Appendix. Some comments on oil drop experiment error analysis.

Systematic error

$$X_{\text{meas}} \equiv X_{\text{true}} + e_s + e_r$$

$$\Delta Q \approx Q \sqrt{\left(\frac{\Delta S}{S}\right)^2 + \left(\frac{\Delta T}{T}\right)^2}$$

$$\frac{\Delta S}{S} = \sqrt{\left(\frac{\Delta d}{d}\right)^2 + \left(\frac{\Delta V}{V}\right)^2 + \left(\frac{3}{2} \frac{\Delta x}{x}\right)^2 + \left(\frac{3}{2} \frac{\Delta \eta}{\eta}\right)^2 + \left(\frac{1}{2} \frac{\Delta \rho}{\rho}\right)^2 + \left(\frac{1}{2} \frac{\Delta g}{g}\right)^2} \approx \sqrt{\left(\frac{\Delta d}{d}\right)^2 + \left(\frac{3}{2} \frac{\Delta x}{x}\right)^2}$$

$$\Delta T = \sqrt{\left(\frac{3/2}{t_g^{5/2}} + \frac{1/2}{t_g^{3/2}} \frac{1}{t_{\text{rise}}}\right)^2 \Delta t_g^2 + \left(\frac{1}{t_g^{1/2}} \frac{1}{t_{\text{rise}}^2}\right)^2 \Delta t_{\text{rise}}^2}$$



Appendix. Some comments on oil drop experiment error analysis.

Result of measurement Systematic error

$$X_{\text{meas}} \equiv X_{\text{true}} + e_s + e_r$$

Correct value

Random error

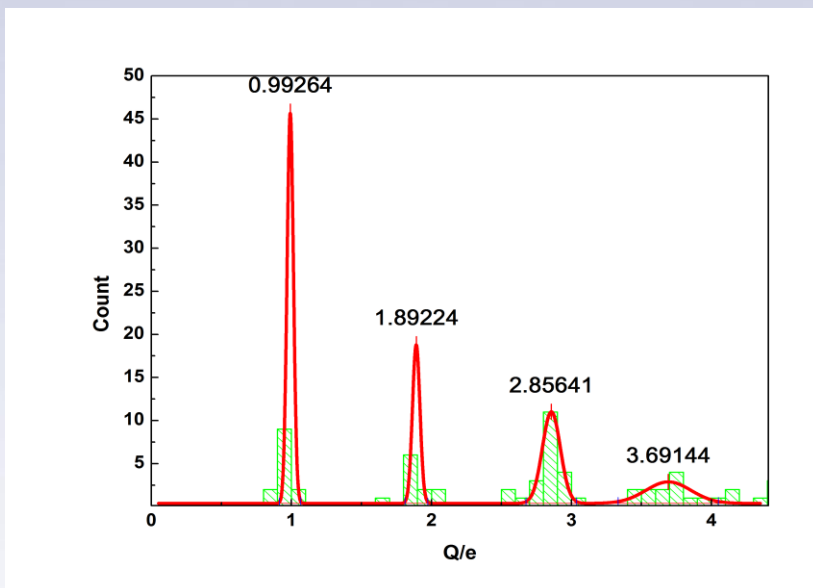
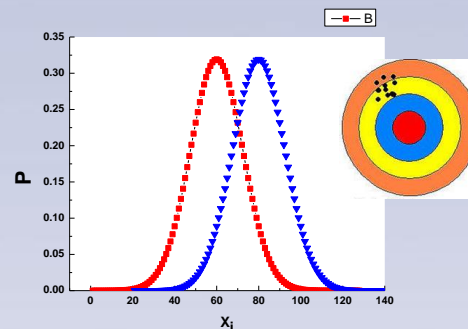

Mean of $\{x_i\}$

$$\mu = \frac{1}{N} \sum_{i=0}^{N-1} x_i$$

Standard deviation of $\{x_i\}$

$$\sigma^2 = \frac{1}{N-1} \sum_{i=0}^{N-1} (x_i - \mu)^2$$

Standard deviation of mean

$$\sigma_X = \frac{\sigma}{N^{1/2}}$$

